



ANIMAL TRANSPORT GUIDES

Guide to good practices for the transport of pigs

2017



For more information:
www.animaltransportguides.eu



Acknowledgements



Citation

Please refer to this document as: Consortium of the Animal Transport Guides Project (2017-rev1). Revision May 2018 ‘Guide to good practices for the transport of pigs’

Correspondence

Any correspondence relating to this project should be sent by e-mail to:
hans.spolder@wur.nl

DISCLAIMER

The positions expressed in this report do not necessarily represent in legal terms the official position of the European Commission.



Contents

0. Introduction	5
0.1 Approach and Acknowledgements	5
0.2 Aim of this guide	8
0.3 Main welfare risks during pig transport	8
0.4 Animal Based Measures	9
0.5 Structure of the guide	12
0.6 List of definitions	12
1. Administrative issues	15
1.1 Introduction	15
1.2 Administration	16
1.3 Competence and training	17
1.4 Responsibilities	18
2. Journey planning and preparation	20
2.1 Introduction	20
2.2 Planning the journey	20
2.2.1 Journey duration	21
2.2.2 Contingency plans	22
2.3 Means of transport	26
2.3.1 Vehicle design and maintenance	27
2.3.2 Regulating the environment within vehicles (climate control)	29
2.3.3 Space allowance	29
2.4 Animal related preparation	30
2.4.1 Preparation of animals and equipment	30
2.4.2 Fitness to travel	31
3. Handling and loading animals	33
3.1 Introduction	33
3.2 Loading facilities	33

3.3 Handling during loading	36
4. Travelling.....	40
4.1 Introduction	40
4.2 Driving	40
4.3 Climate control	42
4.4 Care of sick or injured animals	45
Good practices regarding care of sick or injured animals	46
4.5 Water and feed requirements	48
4.6 Emergencies.....	48
Better Practices on emergencies.....	48
5. Unloading animals	50
5.1 Introduction	50
5.2 Design of unloading area.....	50
Good practices on design of unloading area	50
5.3 Care of animals at unloading.....	51
5.4 Cleaning and disinfection of vehicles after unloading.....	52
5.5 Emergencies.....	53
Good practices regarding emergencies	53
6. Stay at control posts, markets and assembly centres	54
6.1 Introduction	54
6.2 Housing	55
6.3 Feeding and watering	56
6.4 Biosecurity, cleaning and disinfection	58
6.5 Emergency.....	61
References.....	63

0. Introduction

Since 1991, the EU has provided a common legal framework on animal transport which was then updated by [Regulation \(EC\) 1/2005](#) on the protection of animals during transport, hereafter referred to as '**the Regulation**'. It came into effect on the 1st of January 2007, and aims to provide a level playing field for operators while ensuring sufficient protection for the animals being transported. The content and impact of the Regulation has been the subject of a Scientific Opinion from the European Food Safety Authority ([EFSA, 2011](#)), followed in 2011 by an impact report from the Commission to the European Parliament and the Council ([Anon., 2011](#)). In this report, three key recommendations were formulated:

1. The Regulation has had beneficial impact on the welfare of animals during transport, but there is **room for improvement** of the situation;
2. An **amendment** of the Regulation **is not the most appropriate approach** to address the identified problems;
3. As regards the gap between the requirements of the legislation and available scientific evidence the Commission sees that this is best addressed by **the adoption of guides to good practice**.

The European Commission has welcomed the production of "clear and simple guidelines to assess the fitness for transport" prepared by stakeholder groups for [bovines](#) in 2012, and [equidae](#) and [pigs](#) in 2016. It was then considered important to extend this approach to address all aspects of the welfare of livestock during transportation.

0.1 Approach and Acknowledgements

This Guide has been produced within the framework of the Animal Transport Guides project, commissioned by DG SANTE under contract SANCO/2015/G3/SI2.701422. The project started on the 10th of May 2015, **and its main aim was to develop and disseminate good and better practices for the transportation of livestock**. The foundation for this Guide was laid in the first project year, through an extensive literature search and resulting overview of a substantial number of available practices. These overviews of suggested practices can be found on the Animal Transport Guides website: <http://animaltransportguides.eu/>. There is one report for each of five livestock species (pigs, poultry, horses, sheep and cattle). In the second year, these very broad and diverse lists were discussed and largely rewritten, to develop the present five Guides to Good Practices. This involved an intensive process of stakeholder consultation.

The first step in moving from the collection of practices to a draft Guide of Good Practices was taken at member state level. Teams consisting of academic partners from two countries per species (the '**Duo Countries**') took the lead.

- ✓ Sheep: Spain and Romania
- ✓ Poultry: Greece and France
- ✓ Pigs: Italy and France
- ✓ Horses: Italy and the Netherlands
- ✓ Cattle: United Kingdom and France

The academic partners identified practices that are at the level of current EU legislation ('**Good Practices**') and practices that are aspiring more ('Better Practices beyond EU legislation', or simply '**Better Practices**'). The partners then proceeded to ask national stakeholder groups in their own countries to reflect on these suggestions for good and better practices. To support this process and work towards consensus, an iterative Delphi procedure of anonymised input collection was used. Well over 100 stakeholders were involved in this step, representing a variety of backgrounds. The largest number of stakeholders indicated they were farmers (19 individuals), transporters (27), slaughterhouse personnel (13), NGOs (12) and competent authorities (27). Representatives from animal trade, academia and vehicle manufacturers also took part in this consultation process. All discussions were carried out in the national language of the member state involved. The final results of this Delphi procedure were five "Draft Guides to Good Practice". These were not published, but used as the basis for the final Guides.

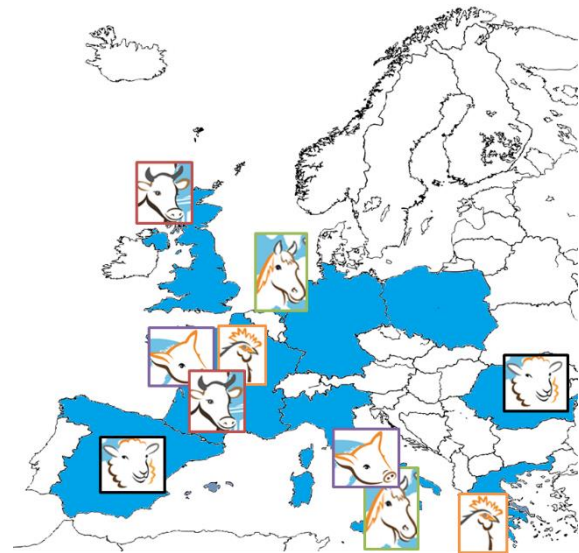

The final Guides for each of the five livestock species were developed through a second round of consensus building at European level, with the help of '**Focus Groups**'. These focus groups had an international basis: the delegates were asked to represent knowledge, experience and opinions beyond those of their own country. **Table 0.1** shows the composition of these five focus groups.

A first series of meetings of the five focus groups was organised at the end of May 2016. During these meetings, the draft guides were presented by the academic partners. A road map to turn the draft guides into the current final versions was then agreed with the stakeholders. All focus groups held subsequent meetings in Brussels, to discuss and reach consensus on the wording of each single practice to be included in the final Guides. Different species groups had different numbers of meetings, and the last ones were held in March 2017.

To support and help guide the process of writing, the Animal Transport Guides project team set up a '**Stakeholder Platform**'. This group of people provided advice throughout the first two years of the project on how to tackle issues that affect all five species guides. The Platform was composed of representatives from 13 international organisations or stakeholder groups: the International Road transport Union (IRU), the Federation of Veterinarians of Europe (FVE), Eurogroup for Animals, Copa-Cogeca, Association of Poultry Processors and Poultry Trade (AVEC), the German Breeders Organisation (ADT), Eyes on Animals, the Irish Ministry of Agriculture, vehicle manufacturer Pezzaioli, Union Européenne du Commerce du Bétail et des Métiers de la Viande (UECBV), European Forum of Farm

Animal Breeders (EFFAB), the German Transporters Organisation (BDT), and the Greek Ministry of Agriculture. The Platform met 5 times in Brussels over two years.

Table 0.1 Composition of international Focus Groups, involved in the production of the final Guides to Good Practice. The numbers indicate the number of representatives per stakeholder category.

	Sheep	Poultry	Pigs	Horses	Cattle	Total
Farmers	3	5	3	1		12
Vehicle manufacturers			2			2
Animal traders	1				2	3
Transporters		3	2	3	5	13
Slaughterhouses	2	5		1		8
Official veterinarians		2	1	2	2	7
Animal scientists	2	3	2	2	2	11
Animal welfare organisations	2	3	2	4	5	16
Total	10	21	12	13	16	72

As part of the development of the five Guides, the species Focus Groups and the Stakeholder Platform choose 17 topic areas which deserved extra attention. The practices in these areas were collected in 17 so called '**Fact Sheets**', aiming to summarise and illustrate in an accessible way the most critical aspects of the journey or the most vulnerable categories of animals. Linked to the present Pig protocol, 4 Fact Sheets were produced: **Travelling, Handling and, Monitoring and Evaluation**. These three, and those related to the other Guides, are published in eight European languages.



The target audience for the fact sheets are farmers, drivers, local veterinarians and abattoir staff. The target audience for the Guides to Good Practice are transport organisers, competent authorities and policy makers. The Guides and the Fact Sheets can all be found on the project's website: <http://animaltransportguides.eu/>.

The development of the Fact Sheets and the Guides would not have been possible without the highly constructive discussions at national and international level with the many stakeholders mentioned above. **Their help with this process was essential, and the authors are grateful for the time and knowledge they contributed to the writing of the Guides.**

0.2 Aim of this guide

The present Guide to Good Practice aims to **improve the welfare of animals** during transportation **by providing practical tools** to meet the requirements of the Regulation and to suggest practices which go beyond legislation.

Transport is a stressful situation for animals. This guide lists practices that aim to support entrepreneurs in increasing the quality of the transport of animals in accordance with the Regulation, thus limiting stress to animals and promote animal welfare. The practices in this guide are based on scientific knowledge, scientific literature, experiences and information from stakeholders. No distinction is made by source, unless this is regarded as relevant for better understanding or checking of the background. They can be used to develop company specific guidelines or Standard Operating Procedures for transporters and other stakeholders, or as a reference source for dealing with aspects of transportation in a way which is practical and that supports animal welfare.

Similar guides are developed with good practices for horses, cattle, poultry and sheep.

This document is not of legally binding nature and does not affect the requirements of the EU legislation on animal transport or other relevant pieces of legislation. Nor does it commit the European Commission. Only the Court of Justice of the European Union is competent to authoritatively interpret Union law. The reader is therefore invited to **consult this guide in connection with the relevant provisions of the legislation** and refer, when necessary, to the relevant competent authorities.

0.3 Main welfare risks during pig transport

Hazards characterized as serious for transported pigs include: inadequate ventilation, insufficient space allowance, transport duration, lack of sufficient water during transport, incorrect handling during loading, poor fitness prior to transport, introduction of pathogens before and during transport and the inappropriate application of resting periods during transport. It is acknowledged that **good preparation and planning** are prerequisites to minimize hazards. Moreover, adequate competence is required to carry out planning and preparation as well as handling and transporting the animals. Chapter 1.3 deals with the required [competences and training](#).

Pigs feel more relaxed and less stressed when handled by staff who **understand pig needs and behaviour**. Well-trained workers are able to load and unload pigs in a relatively short time without stress, thus minimizing the risk of injury, slipping and falling. In addition, good handling has a positive effect on the quality of the carcass and meat. Good handlers are therefore not only aware of the theoretical requirements related to transportation, they also have sound practical knowledge of pig behaviour and the way they respond to humans. This Guide provides some suggestions for that in chapter [3.3 Handling during loading](#).

Some welfare risks are **directly related to the category of pigs** to be transported, as differences in age, sex and size may be associated with different welfare needs. Piglets just after weaning have a weight of 5 or 6 kg. They are relatively weak and sensitive to low temperatures. Older piglets weighing 25-35 kg are stronger and better able to deal with long journeys compared to piglets, although perhaps not as well finishing pigs. Cull sows and boars also require special attention: the reason they are sent for slaughter is often related to health problems such as lameness, injuries or disease.

Regardless of the animal category, pigs are better able to deal with transport stressors if they are **fit when loading**. They must be in good health and grouped in advance in calm conditions. Unacquainted pigs should not be mixed on the vehicle to avoid aggression and injuries. Chapter 2.4.2 deals with [Fitness to travel](#).

The **journey should be as short as possible**, but journey length can always be affected by unforeseen events such as traffic jams, accidents or breakdown of the truck.

The climate on board the vehicle should stay at an acceptable level throughout the whole journey. Temperature and humidity in particular have profound effects on pig welfare as pigs are unable to sweat and lose heat in that way. Therefore it is essential that moving as well as stationary vehicles have **good climate control**. The challenge to avoid heat stress is even greater if space allowances are at the minimum required level. Chapter 2.3.2 deals with [climate regulation](#) on board the vehicle.

Pigs must be allowed to **drink at any time during the journey**. The fasting period prior to slaughter should be carefully planned in relation to the expected length of the journey. Chapter [4.5 Water and feed requirements](#), deals with these issues. To avoid the risk of motion sickness and vomiting the truck should be driven carefully without abrupt braking and acceleration, particularly along curves and roundabouts. Pigs getting sick along the transport may require veterinary assistance and/or euthanasia (see chapter [4.4 Care of sick or injured animals](#)).

During long journeys animals will get tired and **resting periods are required**. [Chapter 6](#) deals with control posts and other places where animals are offloaded, where animals should be housed comfortably with appropriate densities, in good thermal conditions and allowed to drink and eat according to the expected fasting period.

These and several other risks are addressed in this Guide to Good Practices.

0.4 Animal Based Measures

The ultimate aim of providing the right conditions during driving should be to provide good welfare, **so that the animals are healthy and fit when they come off the truck** at the destination. The current legislation, existing guidelines on Fitness to Travel ([Eurogroup for Animals et al., 2012](#)), most quality assurance schemes and also the present guides offer many suggestions on what these conditions should be. They advise for instance on space allowances, frequency and duration of resting and the feed and water requirements of the animals. This advice is based on years of experience or thorough research which has identified the welfare risks associated with deviations from this advice: if space allowances

are too low, animals may not get access to water, may get more easily injured, and may not be able to rest; if they do not rest enough, they will become exhausted, with detrimental effects for welfare and meat quality; etc.

It is important to realise that recommendations based on **'conditions'** (the resources on the truck or the handling and animal management by operators) **do not necessarily guarantee good welfare**: they merely offer advice to maximise the chance that the welfare of the animal will be good. The effect conditions have on the actual welfare status is influenced by other factors, as many of the (recommended) conditions are interacting with each other. Obvious examples are the interactive effects of a wet coat, and ambient temperature: if it is too hot then sprinkling may be desirable, but if it is freezing then you want to keep your animals dry. Another example is the relationship between the driving conditions and the length of the journey: following a rough journey, the benefits of resting the animals outside the vehicle outweigh the stress of offloading. However, if the journey has been smooth and on board conditions optimal, the benefits of offloading will be much lower and in some cases it may even be better to leave the animals on the truck.

Given these limitations of management and resource related practices, it is obvious that **animal based measures can be a useful monitoring tool** to help business operators to ensure welfare and, if necessary, take the appropriate corrective actions. Animal based measures (ABMs), such as injuries, panting, shivering, body and skin conditions, can be interpreted as direct indicators of animal welfare. The use of ABMs during live animal transport is not as novel and innovative as it may sound. Such indicators were included in tools for transporters for a long time and **good professional drivers and keepers already base their actions on the 'signals' they get from the animals** they work with. During routine checks they will not (just) look at the temperature gauge to see if ventilation is adequate: they will look at the animals for signs of panting or shivering. They don't judge tiredness by the length of the journey, but by looking at animal posture and resting behaviour.

Animal Based Measures can be of use **before, during and after** a journey (Table 0.2). They can be used during routine checks to assess how the transport is going, and if action is necessary to improve animal welfare. They can also be used after a journey, when animals are unloaded, to know how the animals have experienced the transportation. Knowing this will help the transporter (and others who handle the animals) to improve the conditions during the next journey with a different consignment.

Table 0.2: To achieve the objective of 'good' transport regarding the welfare of pigs, the following ABMs should be used in monitoring tools.

Animal Based Measures	Description
Dead on arrival	Death is indicated by cessation of breathing and absence of a pulse (cardiac arrest). All animals which are found dead on the floor in the truck or die during unloading are considered dead animals
Dead in resting pen	Number of unloaded pigs found dead in the resting pens

Severe lameness or non-ambulatory	Lameness describes an abnormality of movement and is more evident when the legs are in motion. It is caused by reduced ability to use one or more limbs in a normal manner An animal is considered non-ambulatory when it cannot rise or is unable to stand unaided, but is still alive
Slipping	A slip is when a pig shows a temporary loss of balance without a non-limbic part of the body touching the ground
Falling	A case of falling is when a pig shows a loss of balance in which other part(s) of the body (beside legs) are in touch with the floor
Reluctance to move	A pig shows reluctance to move when during 2 seconds at least it stop and does not explore or does not move the body or does not move the head
Turning back	When unloading is observed, turning back is when a pig faced towards the unloading zone turns around its body and faces the lorry area
Activated thermo-regulation	During unloading, activated thermoregulation is visible through shivering or panting. The occurrence of both phenomena is observed during unloading. Shivering is defined as a slow and irregular vibration of any body part, or the body as a whole. Panting is defined as breathing in short gasps carried out with the mouth open
Too low body condition	The spine, hip and pin bones of the pigs to be scored are visually inspected, considering how visible the bones are. The focus of this measure is on the number of animals that are too thin. Animals with visible spine, hip and pin bones will be scored as too thin
Cleanliness	The animals are assessed for presence of manure/faeces on their body on a three point scale. The assessor must have an unobstructed view of 1 side of the body of the animal. The following standards apply for each score: Growing and finishing pigs: 0-Less than 20% of the body surface is soiled; 1-More than 20% but less than 50% of the body surface is soiled; 2-Over 50% of the body surface is soiled Sows: 0-Less than 10% of the body surface is soiled; 1-10%-30% of the body surface is soiled; 2-More than 30% of the body surface is soiled
Sick pigs	The animals/pens are examined for the following disease symptoms: - heavy and laboured breathing, and the chest is rising and falling with each breath? If Yes, the animal is counted as a case of hampered respiration - internal tissue extrudes from the rectum? (the animals should be examined from rear) If Yes, the animal is counted as a case of rectal prolapse - liquid manure (more fluid consistency than normal) is present in the pen? If Yes, the pen probably has animals with scouring (enteric disorder) and is counted as a pen with diarrhoea

Coughing	Coughing is defined as a sudden and noisy expulsion of air from the lungs
Wounds on the body (integument)	Skin damage can present as either lesions (surface penetration of the epidermis) or wounds (penetration of the muscle tissue). At the same time, it can be defined as scratches or round lesions.

0.5 Structure of the guide

Transport spans a **chain of events** from preparation to unloading. To facilitate the use of the guide in every day practice, it will be structured according to six stages of the journey:

1. Administrative issues
2. Preparation and planning
3. Handling and loading animals
4. Travelling
5. Stay at control posts, markets and assembly centres
6. Unloading animals

Stages 2 – 6 follow transport activities in chronological order. The first 'stage' is added because administrative issues, including staff competence, training etc. are important for the execution of almost all activities during transport of animals. Each stage is subdivided into a number of aspects, and for each of them this guide presents 'good practices' as well as 'better practices beyond EU legislation'. See below for definitions.

The practices are not equally important in terms of their expected impact on animal welfare. Therefore, this guide suggests topic areas which are very important, and areas which are relevant but less important. The very important topics will be 'boxed' throughout this guide.

The digital version of this Guide includes words or references with so called '**hyperlinks**'. Clicking on these links (usually with 'Control' + 'left mouse click') will lead to another related part in this Guide, or to background information in documents or on websites, providing of course the reader has internet access on his reading device.

0.6 List of definitions

For the purpose of this guide:

- '**Good practices**' are defined as: procedures and processes that ensure compliance with requirements of legislation or regulations, designed to protect the animals' welfare.
- '**Better practices beyond EU legislation**' are defined as providing additional guidance on how procedures and operations can be improved to exceed any legally defined minimum welfare requirement, and to increase the welfare status of the

animals during the relevant periods and procedures. They will be abbreviated to 'better practices' throughout the document.

In addition to the above operational definitions of good and better practices beyond EU legislation, below is a list of terms used in this document which may need a precise description to avoid confusion. Where appropriate, they have been taken from the Regulation (**Table 0.3**).

Table 0.3 List of terms used in this guide

Assembly centre	Places such as holdings, collection centres and markets, at which domestic Equidae or domestic animals of bovine, ovine, caprine or porcine species originating from different holdings are grouped together to form consignments
Attendant	A person directly in charge of the welfare of the animals who accompanies them during a journey
Breeder sows and boars	Young animals for breeding
Competent authority	The central authority of a Member State competent to carry out controls on animal welfare or any authority to which it has delegated that competence
Control post	Places where animals are rested for at least 12 hours or more pursuant the rules for journey times and resting periods set up by the Regulation. They must be approved by the competent authorities
Cull sows and boars	Adults breeder pigs destined to slaughterhouse
Fattening pig	Pig from 10 weeks destined to slaughterhouse
Journey	The entire transport operation from the place of departure to the place of destination, including any unloading, accommodation and loading occurring at intermediate points in the journey
Keeper	Any natural or legal person, except a transporter, in charge of or handling animals whether on a permanent or temporary basis
Long journey	A journey that exceeds 8 hours, starting from when the first animal of the consignment is moved
Navigation systems	Satellite-based infrastructures providing global, continuous, accurate and guaranteed timing and positioning services or any technology providing services deemed equivalent for the purpose of this Regulation
Official veterinarian	The veterinarian appointed by the competent authority of the Member State
Organiser	(i) a transporter who has subcontracted to at least one other transporter for a part of a journey; or (ii) a natural or legal person who has contracted to more than one transporter for a journey; or (iii) a person who has signed Section 1 of the journey log (when applicable)
Place of departure	The place at which the animal is first loaded on to a means of transport provided that it had been accommodated there for at least 48 hours prior to the time of departure;

	However, assembly centres approved in accordance with Community veterinary legislation may be considered as place of departure provided certain conditions (see Article 2 r of the Regulation)
Place of destination	The place at which an animal is unloaded from a means of transport and accommodated for at least 48 hours prior to the time of departure; or slaughtered
Transporter	Any natural or legal person transporting animals on his own account, or for the account of a third party
Unweaned piglet	Pig from birth to weaning
Vehicle	A mean of transport fitted with wheels which is propelled or towed
Weaner	Pig from weaning to the age of 10 weeks

1. Administrative issues

1.1 Introduction

A series of **documents are required by the EU legislation to transport live animals** which must accompany the consignments and might be required at all time by the competent authorities. Having properly prepared the documents required will **prevent unnecessary delays** and additional checks by the authorities.

In addition, **good record keeping** is the cornerstone of quality monitoring: it contributes to **transparency** and supports **quality evaluation**. Records can be used to highlight aspects that went well and to identify weaknesses that need to be addressed. Such evaluations can be done at the level of a specific event such as a single journey, and also by aggregating data at the level of multiple transports. Record keeping is indispensable for **maintaining and promoting adequate standards**.

It is important that data requested to be recorded are **clear and understandable** and easy and quick to log. They should be able to be assessed objectively, and be justified for and proportional to the intended goals, i.e. safeguarding the welfare of the transported animals. Records should not be longer than necessary and what is "needed to know" should prevail over what is "nice to know". Promoting and using **electronic records** facilitates meeting the administrative requirements. Furthermore, synergy can be obtained by linking animal welfare records with health and food safety records.

Transporters should carry the **appropriate documentation with them during the journey**. They are likely to be checked for these papers by the competent authorities either during transport or at any transfer or arrival.

In particular **certificates of competence** must be held by drivers or attendants responsible for transporting domestic Equidae, domestic animals of bovine, ovine, caprine or porcine species and poultry over 65 km. In the EU member states these are mainly independently assessed qualifications specific to the species and duration of journeys involved.

As is indicated in the Regulation, **professional drivers** and attendants should achieve **knowledge of the legislation** in relation to the following topics:

- animal transport,
- animal physiology (in particular drinking and feeding needs),
- animal behaviour and the concept of stress,
- practical aspects of handling of animals,
- the impact of driving behaviour on the welfare of the transported animals and on the quality of meat,
- emergency care for animals and safety considerations for personnel handling animals.

Drivers and attendants need to be able to adequately translate this knowledge into practice. Insufficient knowledge of these issues is regarded as the main risk for impaired animal welfare during transport.

The competent authorities have to ensure that the requirements of Annex IV of the Regulation have been included in a **theoretical examination of applicants**. The content and duration of training courses, the professional qualifications which can be taken into account, and the type of examination are the responsibility of each member state.

1.2 Administration

Good practices regarding administration

1. Everyone transporting animals carries **documentation on the means of transport** stating their origin and their ownership, their place of departure, the date and time of departure, their intended place of destination, and the expected duration of the intended journey.
2. Furthermore, the following document might be necessary to accompany the transport animals in the EU:
 - A **transporter authorisation** for transports exceeding 65 km and up to 8 hours (Type I) and over 8 hours (Type II),
 - A **certificate of approval for transport vehicles** for over 8 hours,
 - A **certification of competence** of drivers and attendants transporting domestic Equidae, or domestic animals of bovine, ovine, caprine or porcine species or poultry,
 - A **journey log** for long journeys of domestic Equidae, or domestic animals of bovine, ovine, caprine or porcine species (not for poultry),
 - **Animal health certificates (where required e.g. trade between Member States or when exporting to non-EU countries)**,
 - **Food chain information** regarding slaughter animals.
3. The transporter shall submit the journey log to the competent authority before the journey commences and is held and fulfilled by the driver during the journey.
4. Animal health certificate and journey log shall be submitted via the electronic application TRACES.
5. On long journeys of domestic Equidae, or domestic animals of bovine, ovine, caprine or porcine species, transporters shall use a **navigation system** compliant with the current legislation.
6. Organisers archive all transport records, animal health certificates and journey logs of every transportation, for at least **three years**.

Better practices regarding administration

7. Transport means provide information about the **net usable surface area** for each loading deck.
8. The data of the journey log are presented in an **electronic format** to be transmitted to the competent authorities.
9. The **categories of animals** within the species are indicated on top of the species (e.g. piglets, sows, fattening pigs).
10. Transport organisers keep transport contracts and journey logs in an archive for **at least 5 years**.

1.3 Competence and training

In general, only skilled workers can complete animal transportation with minimal impact on animal welfare. The skills required ('competence'), obtained through training and work experience in the animal transport chain, enable each operator:

- To have the necessary knowledge about the **impact** of their work **on animal** stress, fear and related injuries,
- To know about the **impact** of their work on the **quality of the meat** of transported animals,
- To recognise the main physiological signs to **judge the state of the animals** before loading, during loading and transport phases and at unloading (e.g. posture, nervousness and stress, etc.),
- To **adapt the journey** to specific conditions (variable sensitivity of breeds transported to stress and mortality, weather conditions, events which can occur during the trip),
- To know the **biosecurity** rules.

Good practices regarding competence and training

11. Transport operators ensure that persons who handle livestock have a basic but detailed understanding of animals' behaviour and physical needs. For an overview of biological needs of pigs whilst travelling see [Chapter 2.4 Animal related preparation](#).

12. Trainers impress upon keepers the potential effects of their actions upon animals in their charge.
13. Transport operators ensure that there is a **commitment to proper handling** from everyone, from the top down, involved with the livestock shipment.
14. Transport operators ensure compliance with the minimum legal training programme required for the Certificates of Competence in Europe according to the Regulation and national requirements if any.

Better practices regarding competence and training

15. A **Welfare Transport Officer** in charge of the training, certificates and check of the quality of the transport is appointed in the transport company.
16. The practical **abilities** of the transporter are **recorded and controlled** (e.g. through audits and checks in the field).
17. **Key parameters** are identified and **recorded** to assess the quality of the transport (e.g. the incidence of mortality, injuries and any animal based measures of animal welfare).
18. Transport companies ensure that drivers (and keepers) receive continuous and **updated training**.

1.4 Responsibilities

Good practices on responsibilities

19. The **keepers and attendants** (including the owners and managers) of the animals are responsible for:
 - a) the general **health**, overall **welfare** and **fitness** of the animals for the journey; these are assessed and recorded by **regular routine inspection**,
 - b) ensuring compliance with any required certification, either veterinary or other,
 - c) the **presence of an animal keeper / attendant** competent for the species being transported during the journey and with the authority to take prompt action; in case of transport by individual trucks, the truck driver may be the sole animal keeper during the journey,
 - d) the presence of an adequate number of animal keepers during loading, and
 - e) ensuring that **equipment and veterinary assistance** are provided as appropriate for the species and the journey.
20. **Business agents** or buying/selling agents are responsible for:
 - a) selection of **animals that are fit** to travel, and
 - b) availability of suitable **facilities** at the start and at the end of the journey for the assembly, loading, transport, unloading and holding of animals, including for any stops at resting points during the journey and for **emergencies**.
21. In addition, **animal keepers** or attendants are responsible for the humane handling and care of the animals, especially during loading and unloading, and for maintaining a record of journey events and problems and the completion of the journey log on long journeys. To carry out their responsibilities, they have the **authority to take prompt action**. In the absence of a separate animal keeper, the driver is the animal keeper.
22. The '**Organiser**' is responsible for planning the journey to ensure the care of the animals. This may be the transporter, the vehicle owner and/or the driver. In particular they are responsible for:
 - a) choosing **appropriate vehicles** for the species transported and the journey,
 - b) ensuring that properly **trained staff** are available for loading/unloading of animals,
 - c) ensuring adequate competency of the driver in matters of animal welfare for the species being transported,
 - d) developing and keeping up-to-date **contingency plans** for all journey types (even when not mandatory) to address emergencies (including adverse weather conditions),
 - e) producing a **journey plan** for **all** journeys (including where mandatory) which includes a loading plan, journey duration, itinerary and location of resting places,
 - f) loading only those **animals** which are **fit to travel**, for their correct loading into the vehicle and their inspection during the journey, and for appropriate responses to problems arising (if fitness to travel is in doubt, the animal should be examined by a veterinarian who is then responsible for declaring any animals unfit to travel),
 - g) welfare of the animals during the actual transport, and
 - h) **planning the journey, which** should take into account any disparity in the requirements for animal journey times and the requirements of the **social regulations relating to drivers' hours**, including the numbers of drivers

required for long journeys to achieve complete compliance. This will ensure compliance with both sets of regulations. This may relate to both driver and animal rest times and a decision on the number of drivers required for long journeys.

23. **Managers of facilities** at the start and at the end of the journey and at resting points are responsible for:
- a) providing **suitable premises** for loading, unloading and securely holding the animals, with water and feed when required, and with protection from adverse weather conditions until further transport, sale or other use (including rearing or slaughter),
 - b) providing an **adequate number of animal keepers** to load, unload, drive and hold animals in a manner that causes minimum stress and injury,
 - c) **minimising** the opportunities for **disease transmission** by detailed attention to vehicle and facility **cleaning, disinfection**, hygiene and environmental control, as well as provision of clean bedding,
 - d) providing appropriate facilities to deal with **emergencies**,
 - e) providing facilities and competent staff to allow the **humane killing** of animals when required, and
 - f) ensuring proper rest times and minimal delay during stops.

Better practices on responsibilities

24. Ensure there are **clear definitions of responsibilities** of keepers, attendants, traders, transport organisers, farmers, assembly centre managers, drivers, control post owners and slaughterers, and that they are listed in the transport contract and to provide a checklist accessible by all staff including the driver(s) or attendants.
25. **Standard Operating Procedures** (SOPs) are established for each activity/task by the agent defined as responsible. These describe **precise protocols** for feeding, watering, renewal and replacement of bedding, animal inspection and monitoring and **definition of those individuals responsible** for each task. SOPs are continuously updated in accordance with new advice and/or guidance.

2. Journey planning and preparation

2.1 Introduction

Good preparation and planning for the transport of pigs is one of the most important stages of the journey. It is the key to successful animal transport in terms of compliance with legislation, best practice and high standards of animal welfare and economic benefit. **Good planning promotes smooth execution** of transport and is needed to minimize the risk that the involvement of the different parties is poorly synchronised. The complexity of the overall animal transport process necessitates **well-structured integration of each of the activities** according to defined sets of objectives, responsibilities and monitoring tasks. The anticipation of **unexpected events** and problems and the provision of **contingency plans** to supplement well defined Standard Operating Procedures are paramount. Next to the immediate animal welfare concerns, planning should include animal health considerations (biosecurity), human health and safety aspects and economic consequences. The importance of planning and preparation is also acknowledged by the EU legislators, and **journey logs with a planning section are obligatory for long journeys.**

From an animal welfare point of view, the 'preparation and planning' stage includes the following aspects:

- Planning the journey,
- Vehicle preparation,
- Animal related preparation,
- Administration.

These aspects are described in the paragraphs below.

2.2 Planning the journey

The journey shall be as **smooth and quick as possible** in order to limit exposure to transport stress. It shall be planned carefully to assure pig welfare conditions during the whole transportation. As part of the planning for each journey, **arrangements shall be made to manage any delay**, breakdown or other emergency to minimise risks of impaired welfare during all transport.

The journey shall be **planned and prepared carefully** after the announcement by the farmer or trader of the date and the place of departure and the destination to the final client. Journey plans involve written arrangements regarding start and unloading places, contingency plans, and details on consignment sheets or arrangements that are in place for rest stops, particularly for long-distance journeys.

In particular, they shall include:

- **description of the route of travel** and estimation of its duration,
- analysis of **weather forecast**,

- choice of the **transport company** and of the truck (e.g. type I or II) and/or vessel depending on journey duration and weather conditions, pig number and categories, i.e. breeders boars and females or fattening pigs, piglets, cull animals,
- The reservation for unloading **resting animals in a control posts** when applicable,
- a **contingency plan**,
- planned **number of drivers**,
- provisions for **bedding material**,
- provisions for **water and feed** to be delivered at control post, depending on trip duration,
- assurances **that the truck is ready** at the place and time appointed for departure.

Table 2.1 Maximum journey times allowed by the regulation (in hours)

	Basic Standard Vehicle	Higher Standard Vehicle		
Pigs apart from unweaned piglets	8	24 (they must have continuous access to water)		
	Basic Standard Vehicle	Higher Standard Vehicle		
		Travel	Rest	Travel
Unweaned piglets	8	9	1	9

The expected overall journey duration for the planned route is determined realistically, taking into account time needed for loading and unloading (**Table 2.1**). If after this journey time the animals have not reached their destination, they must be unloaded, fed and watered and be rested for a minimum of 24 hours at an EU approved control post, see [Chapter 6. Stay at control posts, markets and assembly centres..](#)

2.2.1 Journey duration

The journey duration has to be estimated carefully and include the scheduled rests and stops at control posts. Taking the journey duration into consideration, the right type of vehicle and its equipment should be chosen.

Good practices on the nature and duration of the journey

26. The transport organizer shall choose the transport company according to its authorization, approval of means, ability, experience, capacity and available attendants and drivers.
27. The transport organizer shall define accurately the **journey duration** in agreement with the transport company. This should include the route map, rest stops for the driver and stops in control posts during long journeys. He shall choose the route to minimise the total length of the journey.
28. The transporter should **choose the vehicle according** to the type and number of animals to be transported and to the journey duration (truck equipment according Type I or II authorization).
29. **Clear and effective communication** between the transporter and the loading and unloading locations is essential. This should involve phone or electronic communication

with farms, control posts, markets and slaughterhouses during journey planning to confirm arrangements and requirements and between the driver(s) and all other agents throughout the transport phase/journey.

30. For journeys where animals should be unloaded at a control post the competent authority demands **proof of a reservation** and proof of acceptance of the animals at a control posts *en route* which is mentioned in section 1 of the journey log. This procedure is a part of the checks carried out by the competent authority before long journeys.
31. Duration of the journey breaks should be long enough to **check the animals** for any signs of compromised health or welfare and to check feed and watering systems to ensure adequate supply is available.
32. Time should be allowed during stops to **treat individual animals** if required following inspection.

Better Practices on the nature and duration of the journey

33. Schedule loading and transportation so that animals can be unloaded promptly at destination.
34. Ensure **clear communication between drivers** and personnel at the destination about responsibilities.
35. Attention should be paid to the impact of **thermal conditions** (heat and cold) and humidity **on all journeys** (long, standard or short). Appropriate strategies should be employed on all journey types to minimise the risk of thermal stress.
 - Avoid travelling in the hotter parts of the day by planning the journey to take advantage of cooler conditions at night.
 - Plan short and long journeys to avoid known delays such as road works and diversions.
36. The transport organiser should ensure that all required paperwork (e.g. livestock manifests, bills of lading, emergency contact information) is completed in compliance with regulations but should also provide all completed documentation in a timely manner to the transporter so that the vehicle can leave immediately after loading.
37. The transport organiser should **avoid rush-hour traffic** to cross urban areas.
38. The transport organiser should consider the time spent on a lorry loaded onto a vessel as **journey time**, and not as a break time.

2.2.2 Contingency plans

The main goal of the transporter is to deliver the animals timely and in good welfare conditions, despite risks of delay on the road. Emergencies may occur, even when optimal preparation and planning has taken place. **The contingency plan aims at helping the driver and the transport company to ensure the security and the welfare of the animals in case of emergency.** The Regulation mentions these as a requirement for long journey transporter authorisation, but they are also useful for short journeys. Contingency plans are most useful when they are regularly trained and updated by the transporter. They should address 4 questions: what **potential risks** may cause an emergency, **what can be done** when they occur, **who is to do what** and **how will the mitigating actions be carried out.** By being prepared, the transporter will be able to respond in an effective

manner and reduce the impact of a delay or accident on the animals. **Figure 2.1** provides an example taken from the [Practical Guidelines to Assess Fitness for Transport of Equidae \(2016\)](#).

Annex III— Example of UK contingency plan

Council Regulation (EC) 1/2005
Contingency Plan Template For Type 2 Transporters

Please complete this Contingency Plan and submit to the following address with your application form for a Type 2 Transporter Authorisation:

This generic Contingency Plan is to be completed by the Transporter.

Section 1 – Contact Details

Name of Transporter

Address:

Contact Telephone Number Email Address

Section 2 – In case of an emergency:

- 1 Who is your nominated vehicle breakdown/recovery company?
- 2 What action will you take in the event of a traffic accident, road closure or weather conditions delay your journey?
- 3 What action will you take if the ferry/shuttle service has been suspended?
- 4 What action will you take in the event that your vehicle suffers an irreparable breakdown?
- 5 What action will you take if any animal(s) become ill during the journey?
- 6 What action will you take if any animal(s) needs to be euthanised?
- 7 What action will you take in the event that you encounter extreme temperatures (either hot or cold) during the journey?
- 8 What action will you take if there is confirmation of a Notifiable Disease in an area you're travelling through?

Transporter Signature

Name in BLOCK LETTERS Date

Figure 2.1 The structure of a contingency plan, from the Practical Guidelines to Assess Fitness for Transport of Pigs (UECBV et al, 2016).

Good practices regarding contingency plans

39. **If a delay occurs**, the welfare and safety of the animals must be considered paramount at all times. It is the driver's responsibility to keep the animals comfortable and safe and ensure the journey time is kept to a minimum.
40. The driver should make every reasonable effort to minimise the delay and ensure that **water, shade on a hot day, and adequate ventilation are available**.
41. If necessary, the **driver should seek the help of the police** to enable his journey to continue as soon as possible during long traffic hold-ups (i.e. if the road is closed due to an accident).
42. In the case of a **mechanical breakdown** of the vehicle, the nature of the breakdown should be determined and it should be estimated how long the repairs will take. If the repairs cannot take place at the site of the breakdown or they will take an extended period of time, **arrangements for another vehicle** will have to be made.

43 A contingency plan should be present in the vehicle. An example is provided in Figure 2.1. The plan should be known and understood by everyone involved in animal transport during any journey. It needs to describe how to handle unforeseeable incidents and delays to ensure the animals do not suffer significant harm. Delays can be caused by weather, traffic issues, accidents, road construction, mechanical breakdowns or plant shutdowns. The contingency plan must amongst other things include the provision for facilities to hold animals in emergencies.

44. In case of emergencies the contingency plan is activated by the driver and/or transporter, whoever is first aware of the emergency.
45. The contingency plan should **include the following elements**:
 - a) Solutions how a **constant contact** can be organised between the transporter and the driver/s,
 - b) Solutions how a **contact to authorities** can be warranted (police/veterinarians),
 - c) A list of **contact-phone numbers** of all parties involved, including the phone-number of the insurance-company for the pigs,
 - d) Solutions how **local breakdown services** can be organised, how a taking over of the shipment can be organised (substitutes),
 - e) Solutions to **arrange repairs** in case of a damage to the vehicle,
 - f) Solutions to **unload animals** in case of emergency or delay: **places where animals can be unloaded** are identified throughout the planned route, and this information is readily available to the driver.
 - g) Solutions how **water, food and bedding** can be organised for animals in the case of unforeseeable long delays (e.g. at border crossings),
 - h) **Other matters** necessary to ensure the animals do not suffer significant harm as a result of delays during transport.
46. **Animals may become injured** during transport and it may be necessary to humanely kill an animal before it reaches its destination in order to prevent the animal suffering further pain or distress. Therefore the transporter should have readily available the

- contact details of a veterinarian** or licensed slaughter man competent in humane killing at locations along the journey or at the destination.
47. Only drivers or attendants who have a certificate of competence and have received specific training in the field of animal emergency care, may **attend to animals injured** during transport.
 48. For piglets, in case of engine failure, organise another truck for reloading.

Better Practices regarding contingency plans

49. A contingency plan should also be drawn up and in place for **short transports under 8 hours**
50. In order to be properly prepared for an accident, each transport vehicle should contain the following:
 - a) Emergency **contact sheet** with 24-hour phone numbers for dispatch, destination point and local competent authorities, available veterinary surgeons, emergency services, emergency plant operators and insurance companies,.
 - b) Emergency **warning devices** (e.g. flares, emergency triangles) consistent with European requirements.
 - c) **Camera** / mobile phone camera
 - d) Accident **information sheet**
 - e) Company **accident policy sheet**/Standard Operating Procedures,
 - f) Fire extinguisher**
 - g) **Spill containment** or cleaning kit
51. The transporter should constantly **monitor the comfort and condition** of the animals during any delay. For all pigs to slaughter, during any delay **a driver should check the pigs** he can see for signs of panting and take appropriate remedial actions
52. The transporter, in the case of delay, should **contact the origination and/or the destination contact persons** to inform them of the nature of the delay and determine the best plan of action for themselves and for the well-being of the animals
53. Provision for **convenient and simple emergency access** should be present on vehicles to make it easier to inspect the pigs and provide assistance to animals in need
54. Emergency procedures are **periodically tested** and discussed with personnel through internal audits, and amended as necessary
55. Equipment kept for **emergency euthanasia** is well maintained and can be operated efficiently; documented training and equipment maintenance records are kept
56. Information on how to transport animals (incl. issues related to emergencies) **is shared between transporters**, and what works or does not work is evaluated regularly.
57. For piglets at risk of heat stress in low humidity circumstances, **water should be sprayed on the floor** of the truck
58. In case of engine failure when transporting piglets **there should be an emergency generator** – so the fans can be kept running and the temperature, air flow and oxygen can be controlled

2.3 Means of transport

Vehicle design, maintenance, preparation and operation are key factors in ensuring high standards of animal health and welfare during transportation. A major risk to animal welfare is presented by the physical environment experienced on the vehicle, **in particular related to the thermal environment**. Therefore, it is vital to ensure that ventilation regimes are effective in maintaining internal conditions that are not only compliant with legal requirements but are as close to the thermal optimal for the animals being carried. Adequate and appropriate ventilation systems are essential because during journeys of any duration weather conditions may change imposing varying thermal loads upon the transported animals. Seasonal differences in weather conditions will constitute also a risk in terms of thermal stress.

On long journeys on which animals may move across climatic zones the risk of thermal stress is increased. Mechanical ventilation should remove heat and moisture to provide an environment in which any risk of thermal stress is minimised. Design and operation of such systems should be based upon an understanding of the animals' requirements over and above the specifications provided in current legislation. It is essential to understand the **principles of upper and lower critical temperatures** and thermo-neutral zones to ensure effective specification of ventilation requirements and operational strategies. Further factors including humidity and wetness of skin can also influence the acceptable temperature range.

Ventilation systems are either **free or forced systems**. Free ventilation systems are common in vehicles used for short (less than 8 hours) journeys, whereas forced systems are a requirement for long journey vehicles. According to the Regulation, the minimum air flow rate of fans should not be lower than 60m³/h per 100 kg live weight. The efficacy of forced ventilation systems becomes especially important with regard to **transports from Northern Europe to Mediterranean regions** and their hot climates. For instance, frequent stops due to traffic or border controls in hot climates can lead to heating up the vehicle interiors resulting in heat stress for livestock. Ventilation is also important in limiting the concentrations of ammonia from faeces and urine and of carbon dioxide from exhalations inside the vehicle.

Poor suspension can also affect animal welfare. Excessive vibrations can lead to symptoms ranging from nausea to muscular fatigue. Pigs can suffer from travel sickness, particularly if they have been fed close to collection and vehicle suspension is worn.

Non-slippery **floor surfaces** are essential for preventing falls during transport and also during loading and unloading procedures. **Bedding material** can help. This should be dry with high ability to soak up fluids. Sufficient amounts of bedding allow for more comfort and facilitate the resting of animals.

Scientists recommend that besides the legally required parameters, **monitoring of parameters** such as relative humidity, vibration and total loaded weight could provide additional information for assessing welfare during transport. However, much of the equipment (e.g. that for measuring relative humidity) is still not sufficiently robust or accurate enough for routine application in commercial transport. The automatic control of

mechanical ventilation by the monitored temperature of a control system is technically feasible and new evidence suggests that it would be beneficial in animal transport.

2.3.1 Vehicle design and maintenance

Pig comfort during transport is highly dependent on vehicle design and driving method as well as the quality of road being traversed; pigs are likely to feel themselves unstable, unsecure and frightened if the deck floor is slippery and not uniform and the truck suddenly changes direction and speed. This can lead the pig to fall on the floor, bump up to the compartment sides, to knock against possible sharp edges of the truck structure or even to fall down from an open side of the truck gate and be exposed to consequent fear, bruises, pain and injuries.

In the case one pig gets weak or slightly injured along the journey it will try to seek for a **separated space**, away from other pen mates, to try to recover.

Animals also need **space** and **light** to feel themselves confident with the surrounding environment when they are handled and moved to and from the truck compartment.

Pigs better cope with heat stress during transport if they are allowed to access **drinkers** easily without suffering from thirst and/or getting into competition with the other pen mates.

The main risk factors related to vehicle design consequently are:

- insufficient width or height of the gate (Risk of injuries and air quality),
- inadequate structure of sides (sharp protrusions, sharp angles, open sides, short sides) in the gate (Risk of injuries and bleeding),
- inadequate partitions between compartments (Risk of injuries and pain),
- inadequate lighting (Risk of injuries and fear),
- inadequate drinking equipment (Risk of competition, fights, wounds, thirst and heat stress),
- inadequate truck roof design (Risk of ventilation and air quality),
- inadequate floor condition like gaps and steps (Risk of injuries, difficulties to load the pigs, slipping and falling),
- inadequate floor surface (too slippery, too rough) in the vehicle (Risk of fear, injuries and slipping and falling).

All things being equal, the effect of the design and facilities of the transport vehicles will become more apparent as transport distances increase and weather conditions become more extreme, whether this is very cold or very hot weather.

Good practices for vehicle design and maintenance

59. Trucks should be equipped with loading and unloading facilities which should be **compatible with the (un)loading equipment** of the places of departure and destination. For instance if all farms and places of destination are equipped with loading dock and ramp at piggery level, the back loading ramp(s) of the truck should be equipped with fixed back doors only, and have hydraulically or mechanically elevated decks in the truck (e.g. 2 or 3 levels).

60. In case the piggeries are not equipped with a loading ramp and the pigs are loaded from the ground level of the piggery, **the truck should be equipped with a loading back platform** (hydraulic or mechanic lift). The loading platform must be secured with railing to prevent animals from falling out or escaping during loading and unloading procedures.
61. An international transporter who works in all areas in Europe, should equip the trucks with **hoisting back platforms** associated with hydraulic or mechanic total deck for each floor of the truck.
62. Partitions must be designed so that the animals cannot jump over them and/or cross the compartments.
63. The truck must be equipped with means to **separate weak and slightly injured pigs** from other pigs.
64. All the vehicles with moveable decks shall be equipped with a **ramp with side protection** because in case of emergency during the road transport, it could be necessary to transfer the animals from one vehicle to the other. Without an appropriate ramp this is impossible. If the ramp is detachable and stored underneath the vehicle, it can be used for both the truck and trailer.
65. Appropriate measures must be taken to **prevent engine exhaust** from entering the area occupied by the animals.
66. **Lighting** must be provided on the livestock container which is sufficient to load and unload safely and allows for inspection and care of the animals during transportation.
67. Side openings in the animal compartment must be closable to protect pigs **from cold and rain**.
68. Nipple drinkers should be available at a rate of **1 nipple every 10-12 pigs**.
69. **Height of drinkers should be maximum 30 cm or 50 cm**, for weaned piglets and fattening/adult pigs, respectively.
70. Constant water flow of nipple drinkers for fattening pigs should be checked before and after long journeys.
71. **Tyre pressure** shall be checked before transporting animals.
72. Suspensions shall be kept well maintained since it will reduce vibration, reducing stress to the animals.
73. **Temperature sensors** in vehicles for long transport must be placed at least 80 cm to one meter above the floor, to ensure correct measurement.
74. The driver should be able to **monitor the animal compartment temperature** in the truck cabin and/or through a warning system during long transports.

Better practices for vehicle design and maintenance:

75. The transporter should use a **check list to control the compliance of the vehicle** with minimum requirements for the expected transport before loading.
76. The connection between the cargo cage and chassis should be designed to minimise vibration.
77. **Water devices should be installed on both sides** of the truck to provide access for all animals.
78. It must be possible to **observe the animals at all times from outside the vehicle**, e.g. by opening the side flaps or back doors without the possibility of pigs to escape.

2.3.2 Regulating the environment within vehicles (climate control)

Lack of ventilation can increase both **temperature and humidity** in the truck, with negative consequences such as weight loss, disease or even death of the pigs. It may also increase ammonia concentrations, potentially affecting animal breathing. Ventilation systems are especially relevant during hot weather, when pigs lower their body temperature by increasing respiratory rate. A proper ventilation system must have sufficiently large ventilation openings, traversing the whole length of the vehicle at the animal height. Inadequate ventilation during transport significantly increases mortality.

Good practices regarding regulation of the environment

79. The deck height should be at least according to **Table 2.2**, with reference to the pig live weight. The live weight limits are considered with a tolerance of 5%.

Table 2.2 Good practice deck height at different live weights of pigs

Deck height	Live weight
45 cm	< 10 kg
62 cm	10-25 kg
70 cm	50-70 kg
88 cm	100-120 kg
100 cm	>120 kg

80. **The use of showers, sprinklers or spraying systems** is recommended when the temperature is over 25°C, to cool down the animals. The truck side flaps need to be open to avoid high humidity inside the truck.
81. Ventilation systems of fully conditioned trucks must be able to **function at any temperature**, while the truck is standing still or moving (legal requirement for long transports) and the temperature at animal level must be measurable in the cabin.

Better Practices regarding regulation of the environment

82. Ventilation capacity should be at least **60 m³/h/100 kg pig weight even for short journeys** (for journey over 8 hours this is a legal requirement).
83. The proper functioning of ventilation devices, showers and sprinklers should be checked daily.

2.3.3 Space allowance

Pigs in the vehicle should be provided with enough space to be able to stand in a balanced position and to lie down comfortably. Absolute minimum space allowances are determined by the physical dimensions of animals, but this in itself is not sufficient. Space requirements are also determined by the **ability of the animals to thermo-regulate effectively** and by ambient conditions such as temperature and humidity. The pigs should be offered enough space to lie down. If animals are to be watered and fed on the vehicle, they will

need more space. Space allowances may also need to be greater if vehicles are stationary for prolonged periods, to guarantee adequate ventilation.

Good practices regarding space:

84. **A loading plan should be prepared.** Space allowance requirements depend on the average pig weight and their uniformity, and the need to keep them in groups of familiar or acquainted animals of the same size. Consideration should be given to the presence of pigs with anomalies, which should be kept separate from the other pigs.

Better Practices regarding space:

85. Minimum floor area per pig should be **according to maximum live weights** as presented in **Table 2.3**, which are based on practical experience.

Table 2.3 Guideline on space allowances.

Maximum Live Weight [Kg/animal]	Minimum Floor Space [m ² /animal]	Maximum Live Weight [Kg/animal]	Minimum Floor Space [m ² /animal]
6	0.07	50	0.30
10	0.11	60	0.35
15	0.12	70	0.37
20	0.14	80	0.40
25	0.18	90	0.43
30	0.21	100	0.45
35	0.23	110	0.50
40	0.26	120	0.55
45	0.28	Over 120	0.70

2.4 Animal related preparation

Several aspects of the preparation stage are related to the animals that are intended to be transported. These are addressed to face the main risks mentioned in [paragraph 0.3](#) and aimed to avoid:

- **Excessively long loading time** which can be particularly stressful in hot climate conditions in a stationary truck, in which ventilation is critical,
- **Poor fitness of pigs** to travel which can worsen during transport and become dramatic and causing animal suffering.

2.4.1 Preparation of animals and equipment

When pigs are removed from the pen where they have spent most of their life to be loaded on a truck, they are likely to experience fear and distress. The corridor, the loading dock, the ramp and the truck compartment are unfamiliar environments which require adjusting to. Although research shows that exposure of pigs to early handling can significantly reduce stress responses to pre-transport handling, 'training pigs' is usually not considered practical.

For biosecurity reasons, it is increasingly common to **move pigs into a temporary holding area away from the main herd**, prior to loading onto the transport vehicle. This reduces the spread of pathogens via the driver and transport vehicle considerably. From

an animal welfare point of view it is important that these temporary facilities are meeting the needs of the pigs. Water should be freely available, and the amount of feed offered should be sufficient to avoid exhaustion and cold stress ([EFSA, 2011](#)).

Good Practices on preparation of animals and equipment

- 86. Check before (un)loading the **maintenance of loading quay and lairage pens** (doors, light, ventilation, cleanliness and quality of the floor) to limit the risk that pigs will slip, stumble or injure themselves.

Better Practices on preparation of animals and equipment

- 87. Pigs should be selected and **identified by a marker** before the transport vehicle arrives to avoid unnecessary delays.
- 88. Pigs for transport should be moved into a **temporary lairage pen** next to the loading quay before the arrival of the truck. This will reduce loading time, stress and mortality during loading and transport.
- 89. Access to **drinking water** should be provided in the lairage pens through easily cleanable drinkers.
- 90. **Water, sprinkler devices or forced ventilation** should be used in hot climates in holding pens to cool pigs down.
- 91. Fattening pigs should **not be fastened more than 24 hours before slaughter**. Fasting should start 10 to 12 hours before loading in case of transports less than 8 hours long or 5 hours before long transport exceeding 8 hours. **Table 2.4** illustrates this practice.

Table 2.4 Recommended fasting period before truck arrival

Duration of transport	<8 hour	>8 hour
Slaughter pigs and cull sows and boars	Minimum 10 to 12 hours	Minimum 5 hours
Piglets (weaned and unweaned piglets) and breeder pigs	Minimum 5 hours	Minimum 5 hours

2.4.2 Fitness to travel

Welfare risks during transport are greater for animals which are injured or sick. Weak pigs have less chance to move away from aggression, and are more likely to lose balance due to sudden stops or accelerations or changes of direction of the vehicle. **For this reason it is essential that all animals are checked before loading to determine fitness for transportation.** The check should include a thorough evaluation of animal based measures related to health and welfare status of the animals (see [0.4 Animal Based Measures](#)). This will reduce the risk that animals sent for transport may not survive the trip, or suffer serious welfare problems.

Good practices on fitness to travel

Guidelines specifically related to fitness for transport have recently been agreed by a consortium of stakeholders in a document called "Practical Guidelines to Assess Fitness for Transport of Pigs" ([UECBV et al., 2016](#)). Below are some of the recommendations from this document that should be followed:

92. **Animals should not be transported** if they are:

- Unable to move or to keep balance
- Showing respiratory distress
- Prolapsed (organs protruding from the body)
- Profuse and continuous bleeding
- In late pregnancy, or having just given birth

93. Animal showing the following signs **should be further examined** and a Go / no Go decision should be made, based on the likelihood of experiencing pain and distress during the journey:

- Difficulty moving
- Lameness (minor or serious)
- Hernia (minor or serious)
- Tail biting (minor or serious)
- Swelling
- Skin lesions
- Wounds
- Abnormal discharges
- Diarrhoea
- Breathing difficulties
- Dangerous animals
- Visually impaired animals

Better Practices on fitness to travel

94. Animals that are pregnant should not be in the last third of pregnancy when transported.

3. Handling and loading animals

3.1 Introduction

Loading starts when the first pig exits the holding or lairage pen of a farm, assembly centre or control post and is moved towards the vehicle, and ends when all the pigs are in the vehicle. Loading is one of the most **stressful times for pigs, and has physical as well as psychological elements**. Physical impacts are related to e.g. aggression if regrouped, tiredness and potential injuries due to distances that have to be walked and obstacles in the pen or raceway. Psychological stress occurs because the animals are forced to leave a familiar environment, often handled by personnel unknown to them.

The two main stress-reducing factors to take into account when loading are:

- The **design of farm facilities** and the design of the vehicle ramp,
- The **handling** of the animals.

3.2 Loading facilities

Poor design of loading and unloading facilities increases the risk of slipping, falling, bruises and injuries and additional stress to the animals, thus producing low meat quality and economic losses. The design of platforms and loading ramps should facilitate **loading and unloading with minimum animal distress and bruising**. Steep loading ramps, for example, should be avoided. These ramps will increase heart rate of pigs: the steeper the ramp the higher the animals' heart rate. A steep ramp may also cause behaviours such as vocalisation, refusal to move, defecation, urination, slipping and running away. Practices that will support good loading facilities are listed below.

Good practices related to loading facilities

95. The slope of the loading ramp should have a maximum angle of 20° , which equates to 36.4cm height / 1m length. See Figure 3.1. Figure 3.2 shows an example of a design that allows calm and orderly loading of pigs.

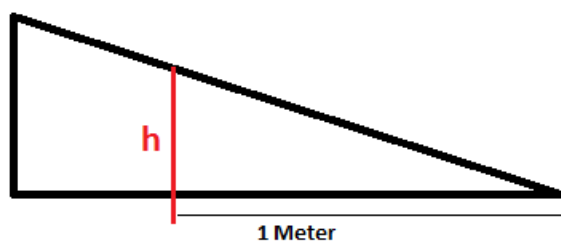

Figure 3.1 Aid for calculation of angle of the ramp: h should be maximally 36,4 cm at 1m.



Figure 3.2 Using the correct angle of the loading ramp and non-slip flooring reduces slipping and falling instances and facilitates smooth loading operations.

96. **There should be no gap** between the loading system of the truck and the concrete platform of the farm loading quay, as this increases the risk of injury and fractures.
97. **Portable or adjustable ramps** should be equipped with anchoring devices to prevent the ramp from moving during loading and unloading.
98. The floor should be **skid-proof** and its composition should ensure that faeces and urine have a limited effect on slipperiness.
99. Duration of **loading time should be as short as possible** to limit pig stress, injuries, related losses of meat quality and mortality.
100. A suitable **source of light** must be present in the compartment and in the loading area and be able to operate throughout the duration of the whole loading stage with the truck engine off.
101. The direction of the light in the loading and unloading shall be from the rear to the front of the animals.
102. During loading/unloading, animals should not move from lighter to darker areas, avoiding contrast of light such as shadows.
103. In case of harsh lights, a cover to dim the lights has to be used.
104. Figures 3.3 and 3.4 provide examples of loading ramps compliant with good practices.

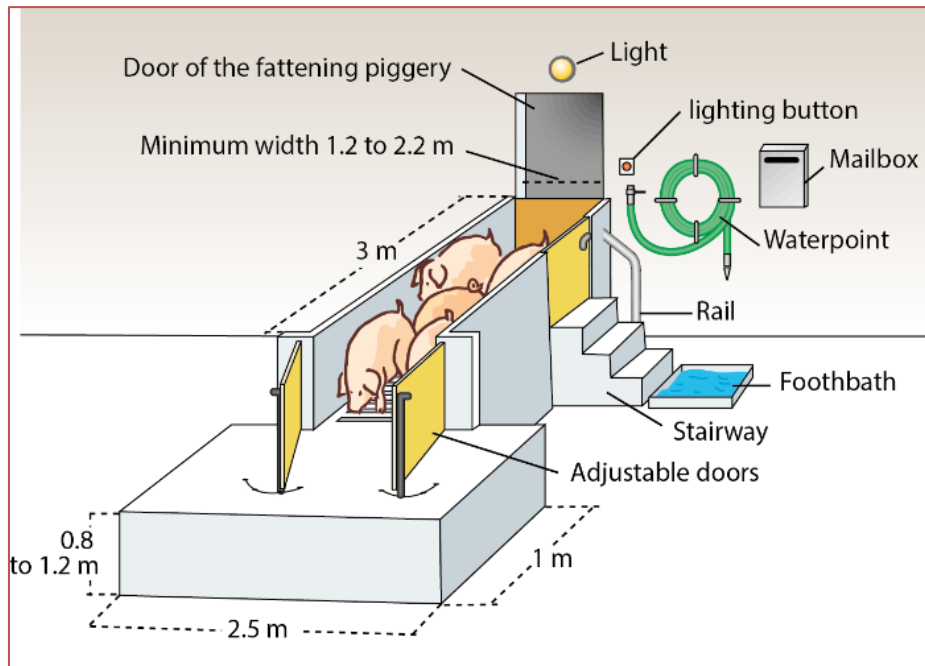

Figure 3.3 Good practice design of loading facilities.



Figure 3.4 Solid concrete loading quay on farm that can facilitate loading operations.

Better Practices related to loading facilities

105. The **ramp has to be solid** and should not bend while animals are moving on the ramp, as they may refuse using it.
106. Traffic areas and truck paths between entrance (of farms, assembly centres, control posts, slaughterhouses), loading and unloading areas and parking should be planned according to the **maximum size for trucks**, trailer and semitrailers and to their radius of curvature (Figure 3.5).

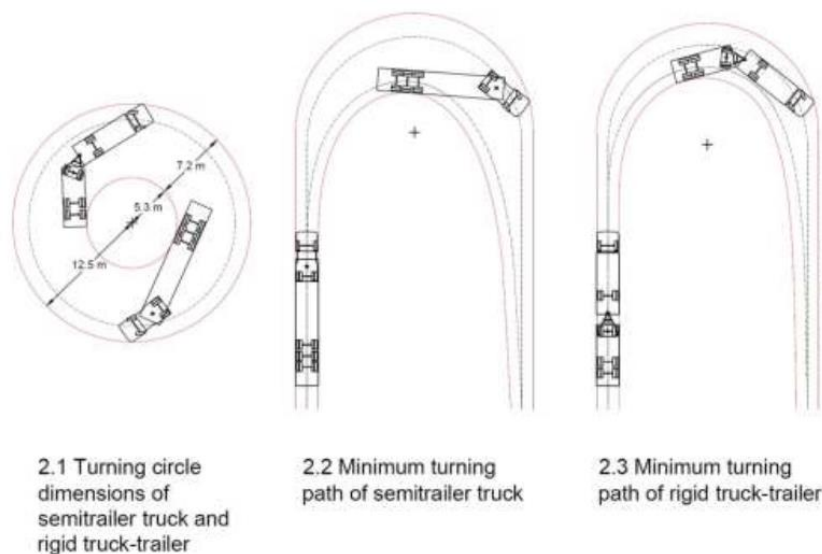

Figure 3.5 Radius of curvature of various types of livestock trucks.

3.3 Handling during loading

It is important to understand the effects that human interactions have on pigs and pig behaviour. A person's intentions are not always understood by the pig and this may create fear and a negative reaction to the handler. This fear can be reduced: pigs that have had regular, positive interactions with people will typically be less fearful and easier to handle. **Pig fearfulness is undesirable** from a handler's point of view: it is **more difficult to move stressed animals**, because they may balk or try to escape from race or pen. Improper handling and transport of pigs is a large profit-reducing issues facing today's pork industry. Evidence of improper handling and/or transport can result in carcass losses because bruises need to be trimmed off, or because the meat is of reduced quality (pale, soft and exudative meat (PSE) or dark, firm and dry (DFD)). Electrical goads are strongly aversive to pigs and increase heart rate by a factor of 1.5. They are also associated with an increased level of carcass damage (SCAHAW, 2002).

Loading and unloading operations should be performed in a calm way by experienced handlers, who **understand the principles of the animal's 'flight zone'** (Figure 3.6).

A **flight zone or safety zone** is the space around an animal where the animal feels safe. If the animal turns away in response to an approaching human, it means that the person has entered the flight zone. The point of balance is usually at the animal's shoulder: all species of livestock will move forward if the handler stands behind the point of balance. They will back off if the handler stands in front of the point of balance. The actual size of the flight zone depends on the tameness of the animal. An approximation can be made by approaching the animal and noting at what distance the animal moves away.



Figure 3.6 Calm handling that makes use of the animals' natural behaviour and "flight zone" speeds up loading operations, improves animal welfare, and reduces economic losses due to injuries and bruises.

Another thing to be aware of is that pigs have wide-angle vision and they can see all around themselves. However, they have a blind spot located right behind them. If a handler positions himself in that spot, the animals can get nervous as they cannot see what is happening. **Handlers should always try to avoid that 'blind spot'** when approaching them. See Figure 3.7.

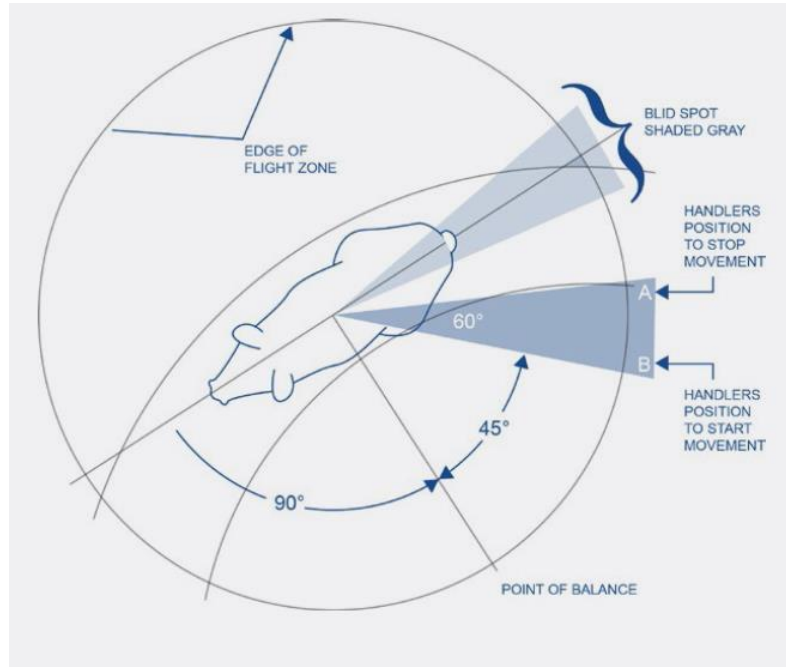

Figure 3.7. Field of vision and flight zone of pigs

Good practices when handling during loading and unloading

107. The time and stress involved in sorting and loading should be reduced as much as possible, and a resting period should be applied in between the two operations. **The duration of the loading phase should not exceed thirty minutes** between the first pig and the last pig entering the truck.
108. Sexually mature sows and boars should be **handled separately** and transported in separate compartments.
109. **Solid wall corridors** should be used. Curved corridors will improve the movement of animals because they are not able to look around the bend to see obstacles.
110. **Steps, narrowing of corridors and bends** at right angle should be avoided.
111. Animals will be slowed down by the presence of objects on the walls along the path (clothing, aprons and plastic bags), grids of canals or water collection wells and floor textures of uneven colour. **These should be removed** prior to use of the race.
112. Pigs are social animals, and they are less stressed in the company of familiar animals. They should therefore be **handled in a group to minimise stress** and to facilitate movement.
113. **Hearing of pigs** is well developed and they are sensitive to high pitch sounds, like shouting, metallic sounds and whistling. These sounds must be avoided to minimize stress, but can be used as an aid when moving reluctant animals.
114. Pigs are **sensitive to bright light** and it takes them several minutes to adapt to light changes, for instance when going from daylight to darkness in the truck. They can be stopped by light reflecting on the truck ramp or any bright metal equipment. It is therefore necessary to avoid light contrasts, or if this is not possible, to give the animals time to adapt.
115. To reduce the field of vision of the pigs and the possibility to turn back quickly, a **sorting board or panel should be used** when moving pigs.

116. If an **animal stops and refuses to move on**, the **following procedure** should be applied:

- behave calmly, and let the animal calm down
- check the animal is not sick, wounded or unfit for transport. If it is, remove it from the race and decide on the course of action
- check for any obstacle on the way and remove them. Check for contrasting lights and adjust lighting accordingly. If all this is not possible, then allow time for the animal to get used to the obstacle
- encourage pigs to move forward by using the following tools or similar devices, but only towards a clear area ahead
 - a plastic rattle or shaker Paddle (noise)
 - a nylon flag
 - a matador cape
 - a plastic ribbon

117. Hitting by hand or stick should be avoided, and never applied to a particular sensitive part of the body, e.g. around eyes and genitals, the belly or the feet.
118. An electric prod should not be used, except as a last option, and only if the way ahead is unobstructed. Shocks shall not be used repeatedly if the animal fails to respond. Electric prods must never be used on sick or injured pigs.

Better Practices when handling during loading and unloading

119. Pigs should be allowed to move to the loading ramp at their **regular walking speed**. Higher speeds will cause loss of balance, slipping and falling.
120. **Any distractions** in the race way such as jiggling chains, flapping plastic, or swinging ropes or other moving objects should be removed.
121. **Noise should be limited** to a minimum level. Yelling or shouting during loading and unloading should be avoided.
122. **Electric goads should not be used at all** to move animals.

4. Travelling

4.1 Introduction

The longer the journey, the greater the risk that welfare is negatively affected. There are four main aspects of animal transport, which have increasing impact on welfare as duration increases. These relate to the **physiological state** of the animal, **feeding and watering**, **rest** and **thermal environment**. If pigs are fit, properly prepared to travel and the journey has been planned well, pigs are likely to arrive at destination in a good welfare state and able to recover quickly after unloading and a relatively short time of rest.

4.2 Driving

Drivers play one of the most important roles in livestock transport. Usually they must take sole responsibility for the welfare of animals on the road. How drivers operate vehicles, how much time they spend checking on animal welfare, and how well they are prepared to deal with emergency situations greatly influences the outcome of any livestock highway shipment.

While standing in a moving vehicle, all livestock struggle to maintain their balance and to avoid contact with other animals. If smooth driving is not provided, they might fail in this effort. Moreover, rough driving impacts negatively upon animal welfare and will increase also imposed stress and the risk of injuring animals. The main welfare impairments related to driving quality include loss of balance. In pigs, this is a relevant stress factor related to transport because **erratic driving obliges them to make continuous postural adjustment** to maintain balance and to avoid falling.

There is a good **relationship** between **driving skills**, the amount of **stress on livestock**, and also the **profitability** of the transport business. Smooth, consistent driving habits allow the animals to relax more during a journey than hard, erratic driving. Scientific studies have shown that not only does a hard driving style increase measurable stress on the animals transported, but it also significantly decreases meat quality. It has been estimated that there is a difference of 20% in fuel efficiency between driving on a flat road at uneven speeds of up to 100km/h compared with a uniform, cruise controlled safe speed of 80km/h. If you encounter a slower driver on a road with no passing opportunities, sit back and take a steady pace rather than hustling a situation you do not control.

The principles of road-holding of an HGV (Heavy Goods Vehicle) and the ability of an animal to be sure-footed are the same. However, the driver has complete control over the vehicle, but only partial control over the animal. Drivers compensate for this partial lack of control by applying knowledge of how an animal will behave under certain conditions. Transported animals have more pressure on their feet than the load on the vehicle tyres, and they will

be working hard to stay on their feet. The more effort they are required to make, the greater the stress they will be under.

Smooth braking helps to keep animals on their feet with a minimum of effort. Hard braking results in more stress, which can lead to bad welfare, and in turn results in poor meat quality.

Good Practices before and when driving

123. Drivers should recognise the difficult conditions under which they work. There are very few drivers on the road that require more skills than the those who transport livestock. Live animal transporters have a vehicle with a high centre of gravity, and a load which is alive and not tied down.
124. **Avoid harsh breaking.**
125. Try to use a **constant throttle**.
126. Check that the brakes and **braking systems** are properly adjusted.
127. Use the **engine break** or retarder if fitted.
128. Fit automatic **anti-lock braking**.
129. Although there are tight time schedules to keep, drivers should phone ahead if they encounter problems on the road instead of putting pressure on the livestock, the vehicle, and themselves.
130. Drivers who observe the following procedures will help assure arrival of stock in good condition:
 - a) **Start out slowly** and avoid fast stops. Fast starts and stops, taking curves too fast, etc., will knock animals down,
 - b) **Keep loaded livestock vehicles moving**, especially during hot weather. This will maintain a constant air flow that will help keep animals cool and prevent build-up of gases from animal wastes,
 - c) Plan to make **periodic stops during transport** to check welfare of stock (Are there any downers? Do any appear ill? Are they too cold or overheated?),
 - d) Make **vehicle security inspections** when checking animals during a stop. Make sure load partitions are in place and secure, trailer doors are securely closed, and bedding is sufficient,
 - e) Be prepared to make decisions or get instructions promptly about how to care for the animals depending on **changing weather conditions**.

Better practices before and when driving

131. Drivers should try to minimise the time for which any trailer containing animals is **left unattended**, particularly where there is any perceived or significant risk to animal welfare.
132. Drivers should **avoid rush-hour traffic** when possible,
133. Drivers should ensure that **during roadside checks they obtain priority** over other vehicles. Priority must be obtained in the interest of animal welfare,
134. Drivers should request **priority in the case of delays** caused by accidents,
135. There should be routine auditing of means of transport and practices of transporters, addressing whether:
 - a) the driver knows the **emergency actions** and has them available in his cab,
 - b) the **trailer is in good state** (sides, flooring, ramps and gates),

- c) the **driver leaves within 15 minutes** after loading the animals,
- d) the driver knows the **plant requirement** for boarding and bedding,
- e) **sufficient water** is available for watering the animals,
- f) the driver has the ability to **adjust trailer ventilation** during the journey if necessary,
- g) the **behaviour of pigs is checked** during the resting periods (e.g. respiratory behaviour, panting).

4.3 Climate control

Pigs transported over long duration **may endure prolonged exposure to extreme heat or cold**, or may endure radical climate changes that can increase transport stress. During the hot season, ventilation rates should be high to maintain the temperature within the thermo-neutral zone of the animals. Air quality should not be a problem due to high airflow rates. During the cold season, ventilation rates will be lower (to maintain a thermo- neutral temperature) and air quality is likely to deteriorate.

During the journey, the driver must be **alert to notice anything that can go wrong**, inspecting the pigs as required, and taking action if a problem arises that affects the animals. To achieve this, it is preferable to have frequent inspection stops during the journey, especially when dealing with long journeys. Thermal adequacy in the truck can be assessed by looking for panting of the animals (which indicates that the temperature is too high). This can also be observed in case of overstocking or poor ventilation in the truck. Huddling of pigs indicates that the animals are cold.

Good practices for climate control

- 136. When in motion, air tends to move from the back to the front of the vehicle. **Active (mechanical) ventilation is more efficient than passive ventilation**- especially on stationary vehicles. In hot weather, avoid parking in direct sunlight for prolonged periods. If practical, park passively ventilated vehicles at right angles to the wind direction, with sufficient apertures open, to optimise air movement through the container.
- 137. **Sufficient ventilation** must be available at all times while the animals are on a vehicle.
- 138. **Never leave a trailer /semitrailer** with animals on board without working ventilation and an attendant nearby.
- 139. **In high temperature conditions**, it is recommended to minimize the number of stops. Otherwise, when possible, the trailer should be parked in an area that provides shade and allows for a breeze to pass through the sides of the trailer and the loading ramp should be opened (Figure 4.1). Do not park near other vehicles due to the potential for reduced air flow and increased risk of disease transfer.
- 140. Weather and in particular **temperature conditions should be considered when making unscheduled stops** or when parking the vehicle including selection of parking locations or locations for driver breaks.



Figure 4.1 In hot weather, trucks should be parked in the shade, with lateral flaps or shutters fully open to allow free circulation of air inside the pig compartment. The ventilation system, which must be available on trucks for long-distance transports, should always be activated during stops.

Better practices for climate control

141. Drivers should ensure that **ventilation is adequate at ALL times** to maintain appropriate thermal conditions and air quality on-board the vehicle / trailer.
142. Animal behaviour and spatial distribution within the container **should be monitored** and any abnormal behaviour associated with inadequate ventilation is acted on and recorded.
143. Action is taken and documented if animals show signs of **overexposure to noxious gases**, such as watering eyes, nasal discharge and coughing, retching, ocular/vision disorders to remove animals from the situation or improve ventilation or otherwise lower levels of noxious gas.

144. **In cold weather**, remedial actions that should be applied when animals show signs of being too cold include (see also Figure 4.2):
 - Reduce space allowance if animals have more than the minimum allowed (e.g. breeding animals)
 - Provide additional bedding or insulation
 - Increase weather protection for animals on vehicles
 - Delay the journey until there are warmer temperatures
 - Protect livestock from wind chill during cold weather by adjustment of flaps or windows and the use of protective sheeting with due consideration for overall ventilation requirements
 - Restrict air movement through trucks by using side covers to partially block air movement through trailers. Be careful to maintain adequate ventilation.
 - Keep animals as dry as possible. Shipment of wet animals may cause death from wind chill.
 - Protect animals from prolonged exposure to freezing rain and sleet. Precipitation in this form can be deadly to animals.
 - Pre-warm vehicles by using heaters prior to loading, particularly for young animals
 - Prevent the freezing of drinkers and/or water lines by the use of heaters or the addition of mixtures (commercially available) such as glycerine and glucose to the water supply

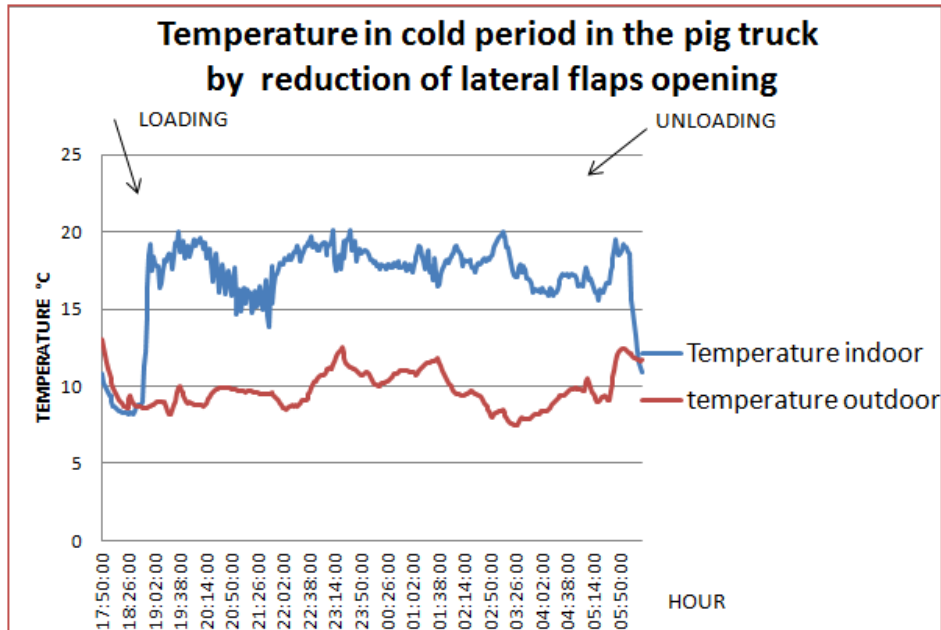

Figure 4.2 In cold weather, pigs may suffer from cold stress. The graph shows how reducing lateral flaps opening rapidly allows to increase temperature inside a moving truck. Other remedial actions to reduce cold stress include: reducing the opening of the vent flaps on the windy side and open on the other side, during stops; adding additional weatherboards, if available, to protect pigs from wind or freezing rain.

145. **In hot weather**, animals should be inspected at every opportunity for signs of heat stress. Remedial actions that should be applied when animals show signs of being too warm include:

- Increasing space by at least 30% – a decision which must be made prior to actual loading commencing and with consideration of the higher risk of loss of balance
- Provision of water or electrolyte solutions
- Increase of ventilation
- Use of climate controlled vehicles (see Figure 4.3)
- Delay of the journey until there are cooler temperatures, e.g. at night
- Provision of drinking water to animals as often as possible



Figure 4.3 Climate controlled vehicles with automatic monitoring allow for easier and more precise adjustment of temperature and ventilation parameters inside the livestock compartment.

4.4 Care of sick or injured animals

Animals should be transported in such a way that each animal can be observed during the journey to ensure their safety and good welfare. **Direct observations** during stops are important, but **video recordings of the animal compartments** may also help.

As indicated in chapter 0.4 Animal Based Measures, **several indicators are useful to identify stressful situations.**

- excited animals, vocalizing and fighting during the journey or when stopped (e.g. stiff pigs under the others, trampled pigs)
- the use of space (in hot condition the pigs use all the space, in cold weather the animals are huddling; see also Figure 4.4) and the posture of the pigs (walking, sitting, sleeping)
- coughing (at stops)
- panting pigs in extreme hot weather: a clear indicator of heat stress (See Figure 4.5)
- an assessment of the fitness of the animals on arrival (see the chapter 2.4.2 on Fitness to travel)
- the cleanliness of the pigs during the journey, including presence of blood, mouth froth and discharge



Figure 4.4 If pigs are huddling, they are showing signs of cold stress. Remedial actions include reducing openings and adjusting the inside temperature, or using more bedding material (e.g. sawdust) to increase insulation of the floor.



Figure 4.5 Panting pigs show signs of heat stress. Remedial actions include immediate opening of all lateral shutters, switching on mechanical ventilation if available, and spraying water.

Good practices regarding care of sick or injured animals

146. Appropriate actions should be taken by the driver regarding **sick and injured animals** during the journey. These are described in Table 4.1.

Table 4.1 Actions required to address adverse effects regarding ill health or poor welfare

Adverse effects	Observations	Action/Precaution
Hunger	Weight loss (in long journeys)	Feeding the pigs in the truck during transport is not recommended as they suffer motion

		sickness. The fasting period on farm before loading should be adapted depending on the planned duration of the journey, to avoid excessive hunger and weight loss (see also section 2.4.1).
Dehydration	Extreme thirst, wrinkled skin, congested mucous membranes	Pigs must have permanent access to water during the journey. Provide fresh, not too cold water
Lack of comfort around resting	Dirty pigs. Animal standing all the time, no animals laying	Bedding Adjust the pen size according to the transported pigs Adapt ventilation by regulating forced ventilation and/or the inlet of lateral shutters
Poor ventilation	Unusual hyperventilation of pig with open mouth and quick respiratory frequency	Check the ventilation, provide sufficient ventilation to the pigs, check the inside temperature. Open all lateral shutters and switch on forced ventilation if available Avoid to stop the truck in an hot place (e.g. sunny place)
Heat stress	Panting	Immediately open all lateral shutters and switch on mechanical ventilation if available Spreading water can be required in very hot conditions to cool down the pigs in the truck
Cold stress	Shivering, skin colour	Reduce opening and control the temperature inside. Use more bedding material (e.g. sawdust) during cold period to increase insulation of the floor in contact with the pigs
Exhaustion	Apathy, reluctance to move, prostration, collapse, mortality	Seek veterinary assistance
Disease	Prostration, collapse, mortality, nasal ocular discharge, abnormal respiration, diarrhoea, blood in faeces	Seek veterinary assistance
Injury and pain	Lameness, reluctance to move, abnormal body posture, skin lesions, swollen joints and feed	Seek veterinary assistance. Try to separate the injured animal(s), otherwise unload them.
Ease of movement	Slipping and falling	Provide grip on the flooring of the truck, the ramp and/or the alley to the resting pen Reduce ramp slope as much as possible (see also section 3.2). The loading quay should be the same height as the first floor of the truck. Handle the pigs in groups and allow sufficient time for them to move safely

Fear	Vocalisation, turning away, reluctance to move	Use calm handling. Check the orientation of the light when unloading (see also section 3.2). Groups of pigs should be kept stable during loading.
Isolation or mixing distress	Skin lesions, fighting	Avoid mixing unfamiliar animals.
Motion sickness	Pigs are easily stressed and can vomit and die during transport	A fasting period before loading and transport is necessary (minimum 6 to 12 hours of fasting period before loading at farm is a usual practice, but one that needs to be adapted to the duration of the journey)

4.5 Water and feed requirements

Water is needed to avoid dehydration and weight losses in the truck. Feed is not supplied during transport on the truck to avoid motion sickness and vomiting. During very long journeys pigs are fed in control posts after 24 hours of transport.

A watering system on vehicles for long journeys is required to avoid thirst, dehydration and weight loss. At control posts pigs can rest and be fed and watered, to recover enough energy to continue the journey.

Good Practices on rest, water and feed intervals

- 147. For sanitary reasons, breeding pigs should be fed at control posts with familiar feed brought from their home farm.
- 148. Ensure that pigs are able to find water while they are on the truck.
- 149. Water supply shall be checked at least daily, and at least twice daily in hot or very cold weather, to ensure the requirements of the pigs can be met.

4.6 Emergencies

Emergency situations are by definition unexpected, and require immediate action. It is important that drivers or other persons in charge **have a plan on what to do**, should an emergency situation take place. The plan should include a series of emergency telephone numbers, e.g. to obtain veterinary assistance.

Better Practices on emergencies

- 150. **In case of a mechanical breakdown** of the tractor, the nature of the breakdown should be determined and it should be estimated how long the repairs will take. **If the repairs cannot take place** at the site of the breakdown or they will take an extended period of time, **arrangements for another tractor** will have to be made. Numerous factors need to be taken into consideration when determining how long pigs can safely be left on a stationary trailer:

- Weather – (e.g. pigs will do fine on a trailer for four hours in cool, low humidity weather. In extreme summer heat and humidity, they will experience heat stress quite quickly),
 - Fitness of the animals,
 - Age of animals,
 - Time since last feeding and drinking,
 - Location of the delay (e.g. rural area vs. freeway),
 - Time of day,
 - Safety of animals at current location.
151. In the event of an **accident**, the transporter should:
- a. **Call the national road emergency number** if the accident occurs on a public roadway or if the emergency assistance is required for an on-farm accident. Advise operator of:
 - The location of the accident,
 - The fact that you have animals on-board,
 - The status of any loose animals,
 - Any known hazards.
 - b. Set out **emergency warning devices** within 10 minutes of accident.
 - c. Call the **designated company contact**. If the company has a dispatch checklist for accidents, proceed through list. If not, inform the dispatcher of the location of the accident, if there are any injuries, condition of animals, position of trailer, number of vehicles involved and if first responders are on scene yet.
 - d. Call other designated contacts according to company protocol. These could include but are not limited to the insurance companies for the cargo and the vehicle and the destination, and provide them with the same information.
 - e. If the tractor and/or trailer are damaged and unable to move, proceed to point g.
 - f. If damage is minor, the trailer is upright and there are no injuries, take photos and record names and addresses of other people involved and witnesses.
 - g. **Herd any loose pigs from the road** and gather them in an area as far away from traffic as possible.
 - h. **Locate accident reporting kit and camera**. Take photos of accident as soon as possible. Photographs should include photos of road conditions, vehicle damage, trailer position, the overall accident scene, skid marks, curves, intersections and where the vehicle left the road (if it did).
 - i. Provide as much **protection and comfort for the animals** as possible
 - j. When first responders arrive, the transporter should advise them of accident details including any human injuries, the status of any loose animals, any known hazards and the company's emergency response plan. If available, the transporter should let the authorities know if a company rescue trailer and animal handling personnel are on the way and their estimated time of arrival. Transporters must respect the chain of command at all times.
152. Pigs that have become injured during transport **should be humanely killed** to prevent further pain or distress. This is particularly true where there is likely to be an unacceptable delay in treating the source of pain, where the pain is untreatable, or where transportation of the animal would aggravate the condition to a significant extent. **A veterinarian should be called to make the decision and to kill the animal humanely.**

5. Unloading animals

5.1 Introduction

Unloading starts with the arrival of the truck to the unloading area of the final destination and ends when all the animals are present on the platform or in the lairage. It is an important phase of the transport process, and is a **stressful situation for the animals due to the rapid changes of their close environment**. Pigs often arrive stressed and tired at a control post or at their final destination. The design of the unloading area as well as the handling skills of the staff should help to reduce stress as much as possible.

Unloading areas should be secure and provide a **wide, clear and straight path** from the vehicle to the holding pens and sufficient staff should be present to unload the pigs as soon as the truck arrives.

As with loading, options that **lower the angle of ramps** will reduce stress and the risk of injury to pigs.

Movements of **small groups of pigs are easier** compared to large groups, because the driver can reach all pigs in the group with less difficulty: welfare is better if compartments are un-loaded one by one. Contrary to expectations, the use of electric goads increases the time necessary to off-load a vehicle, compared with calm un-loading of pens without goads. It is better to use light weight driving boards.

During unloading pigs should be observed carefully, to check their general condition and signs of suffering and/or impaired health. Animal based measures to look out for are apathy, watery eyes, fever, accelerated breathing frequency, abnormal posture, immobility, discolouration of the skin, fatigue, reluctance to move and difficulty in keeping balance. For further information on relevant animal based measures, see Chapter 0.4.

5.2 Design of unloading area

Unloading areas should be secure and provide a wide, clear, straight path from the vehicle to the holding pens. Good and Better Practices related to the design of facilities for pig unloading are described in paragraph [3.2 Loading facilities](#).

Good practices on design of unloading area

153. The unloading quay should **not be sloped nor slippery** and should ensure the safety of the animals.

Better Practices on design of unloading area

154. The number of unloading ramps at a slaughter plant should take into account the speed at which animals are slaughtered. See Table 5.1.

Table 5.1 Number of unloading ramps in relation to the abattoir throughput

Specification	Number of pig per hour at abattoir				
	<200	400	600	800	1400
Minimum number of ramps	2	4	6	8	14

155. For small trucks a special ramp should be used with reduced slopes.

156. The lairage pens should have slatted floors and must be equipped with **showers or misting devices**.

5.3 Care of animals at unloading

Unloading of pigs can cause serious stress and discomfort. It is important that appropriate care is given to the animals, in particular when they have sustained injuries during transport.

Good practices on care following unloading

157. The animals **should be checked** to see that they are fit and have not been injured during the journey.

158. The animals should have **access to food and water**, except in the case where they are unloaded at an slaughterhouse to be killed in a short time frame.

159. The driver of a vehicle should be sure that the **area he has unloaded the pigs into is secure** and that they will not escape after he has left (this is especially important if there is no one there to receive the animals at the destination).

160. The driver should ensure that all the relevant documents are left with the animals at the place of arrival.

161. In slaughterhouses, the **welfare conditions** of each consignment of animals shall be **systematically assessed by the animal welfare officer** or a person reporting directly to the animal welfare officer upon arrival in order to identify the priorities, in particular by determining which animals have specific welfare needs and the corresponding measures to be taken.

162. Where it is necessary to **emergency kill pigs**, it is done promptly, safely and humanely.

163. The animals to be slaughtered as a result of injuries or illness, detected at the time of unloading, **should be done by qualified personnel and killing methods set out in [Regulation 1099/2009](#)**.

164. The personnel involved in killing and related operations and the animal welfare officer shall provide with a certificate of competence.

165. If it is not certain that a pig is dead, then an approved method should be used immediately to ensure death in a rapid and humane manner. If necessary, bleeding-out or another technique should be used to ensure death in unconscious pigs.

Better practices on care following unloading

166. Following the journey, **feedback on pig welfare should be provided by the driver** to the consignor of the pigs.
167. Humane killing should be done with the minimum number of people present to avoid distractions.
168. The pigs should be **handled carefully and be appropriately restrained** so that it is not unnecessarily distressed or alarmed during killing. Where pigs are able to walk, they should be handled in a race or crush.

5.4 Cleaning and disinfection of vehicles after unloading

Bio-security measures are necessary to prevent the spreading of diseases. A clean vehicle is also required because stress during transport may affect the immune system of the animals, and make them more sensitive to disease.

Good practices for truck cleaning and disinfection

169. Trucks should be **cleaned directly after unloading**, and before they enter the overnight parking space.
170. Before cleaning and disinfecting, **dirty bedding should be removed** and conveyed to the manure treatment facility or the manure storage area. The truck compartment should be cleaned preferably using high pressure warm water (>70 bars).
171. During cleaning the operator should wear **protective waterproof clothing**
172. Walls and compartment barriers which are clean but still wet should be disinfected **using authorised disinfectant products**.
173. The cleaning and disinfection area must have **sufficient hot and cold water** available to clean the maximum number of trucks that can stay each day.
174. Cleaning and disinfection areas should be free of obstacles around the truck within a 2 meter perimeter.
175. Lighting must be available at night time. **400 lux should be provided at the level of objects to be cleaned**.
176. All washing equipment and products must be securely stored and protected from weather.
177. **Upper decks must be cleaned first.**
178. The driver must keep a record of each cleaning/disinfection indicating the trade name of the disinfectant product used and the doses.

Better practices for truck cleaning and disinfection

179. The driver should have access to **a list of washing and disinfection areas** in Europe, including their conditions of use, opening hours, availability of fresh water and fresh litter.

180. Lorry wash areas should be 25 m long to accommodate trucks, **with a 5 to 7% slope** to drain waste water to the relevant collecting system.
181. There should be a **checklist on the truck with the main points required for adequate cleaning**, including the bedding material used, water quality, approved program of cleaning and disinfection, the method of inspection, correctives measures, detergent and the disinfectant agents approved and used.
182. Special attention should be given to **disinfecting the tyres and the underneath of the truck**, especially before travelling back to areas/countries with a low disease status.
183. There should be an external lift or stage or platform so that the upper parts of the lorry + roof can be cleaned from outside.
184. There should be **side protections in open disinfecting premises**, so that no pollution from the lorry will contaminate far away surroundings.
185. The slaughterhouse **should have a procedure to verify**: 1) if the drivers apply the standard operating procedure (SOP) for cleaning and disinfection properly; 2) the proper functioning of all washing facilities; 3) the presence and availability of authorised washing products.
186. The number of cleaning and disinfection areas should be adapted to the line speed of the abattoir according to Table 5.2.

Table 5.2 Number of truck washing areas in relation to abattoir throughput

Specification	Number of pigs per hour at abattoir				
	100-200	200-400	400-600	600-800	1400
Minimum number of cleaning and disinfection area	2	3	4	5	9

5.5 Emergencies

Good practices regarding emergencies

187. If animals need to remain in the control post after the truck has departed, for instance because they are injured or unfit to be transported, they must be kept in a separate building, **away from washed and disinfected areas**. The local competent authorities should be informed about the presence of these animals. No disinfection of the pens should take place whilst the animals are still inside them.
188. Trucks with poor ventilation or other complications should receive **priority for unloading**.

6. Stay at control posts, markets and assembly centres

6.1 Introduction

When the journey time exceeds the legal maximum, they must be unloaded in an officially approved **control post**.

The maximum permitted travelling time is of 24 hours for pigs with a tolerance of 2 additional hours to reach the final destination. This additional 2 hours are exceptional only (e.g. in cases of traffic jams) and are not to be included in the planning. At the end of the legal maximum permitted travelling time, the animals must reach the final destination and shall be unloaded for slaughter (in the case of slaughter animals) or for a resting period of 24 hours, which in ongoing journeys has to happen at an approved control post before travelling further

Control posts are facilities which may be attended and inspected by an official veterinarian, and which have been approved by competent authorities based on the requirement of specific EU requirements (Council Regulation EC No 1255/97). At the control post the animals may rest, be fed and watered and cared for during long journeys. **Assembly centres** are places such as holdings, collection centres and markets, at which animals from different holdings may be sold and grouped together to form consignments. Regarding animal welfare and health, the main risks are similar for control posts, markets and assembly centres (see below).

Control posts must be designed, organised and managed to accommodate animals for rest, feeding, watering, and care during long journeys. Housing conditions and staff working at the control post should guarantee that the animals transported receive adequate care according to their status and continue their journey under optimum welfare conditions including compliance with animal-health requirements and bio-security measures. **Therefore, resting periods in control posts must ensure the possibility for all animals to get rest, food and water at the level of their needs.** Then the use of control posts is an efficient mean to improve animal welfare and benefit return for the economic operators during very long transport. Control posts can be approved for pigs, cattle, sheep and/or horses. The booking of the control post has to be done **before the beginning of the transport** and must be indicated in the journey log. A current list of control posts can be found on the internet at the following address:

https://ec.europa.eu/food/sites/food/files/animals/docs/aw_list_of_approved_control_posts.pdf

Main risks of poor welfare at control posts, as well as at assembly centres and markets are related to:

- **Cross-border spread of infectious diseases.** Risks are due to the mixing in the same place of animals of different origin, not only because of the simultaneous presence of the animals in the control post, but also due to poor cleaning and disinfection procedures between successive consignments. The European regulation establishes rules and procedures, applying to a list of diseases. However, the control post owner and staff, transporters and the official veterinarian in charge should also be aware of the possibility that non-listed diseases may spread and should be therefore well informed and trained so as to be able to detect non listed diseases, as well as symptoms or changes in the behaviour of the animals that could indicate health problems.
- **Inappropriate/rough/hasty unloading or loading procedures** which can cause stress and injuries.
- **Inadequate space allowances** and/or pen sizes in the control post that can compromise resting conditions and cause competition and aggressive behaviour between animals.
- **Inappropriate feeding and watering,** and facilities that could cause animals frustration or health problems due to hunger and/or dehydration.

Relevant recommendations can be found in High Quality Control Post Handbook (www.controlpost.eu)

Good practices regarding control posts

189. All control posts are required to have a **closing day for cleaning and disinfection** after 6 days of usage. Any available break in occupation even after less than 6 days of continuous use is exploited to undertake this cleaning and disinfection.
190. A **Proof of an Appointment and a Proof of an Acceptance** of the animals by the control post are shown to the 'loading vet' (the veterinary officer approving the journey).
191. **Only one assembly centre is used** during long journeys, and any resting legally required during a very long transport must be for a full 24 hours at an approved control post.

6.2 Housing

Housing conditions and staff working at the resting places should guarantee that the animals transported receive adequate care according to their status. The resting period should ensure the possibility for all animals to get sufficient rest, food and water.

Good practices for housing

192. Temperature and ventilation should be **maintained within the thermo-neutral zone**, which depends on the type of floor, its insulation properties, the air speed, air temperature and humidity, radiation and the insulation of the building. Table 6.1 provides the thermo-neutral zone for different categories of pigs.

Table 6.1 Recommended temperatures inside a building to minimize health problems for pigs

Animal categories	Minimum temperature	Maximum temperature
Piglets < 15 kg	+20°C	+35°C
Growing-finishing 16 to 110 kg	+15°C	+30°C
Finishing pigs 111 kg to 160 kg	+10°C	+28°C

193. To keep inside temperature above the indicated minimum, additional heating must be applied if necessary. If the temperature is higher than the indicated maximum, additional measures to keep the pigs cool have to be taken: more floor space, additional fans for ventilation, water spraying in conjunction with ventilation.
194. **Building insulation is required** to keep houses frost-free (particularly in fully slatted floored houses). Insulation materials are recommended for the walls to avoid piglets becoming too cold.
195. The control post must have adequate **mechanical or natural ventilation** to provide fresh air and keep the effective environmental temperature as good as possible within the comfort zone of the animals.
196. **Diffuse natural or proper artificial lighting** should be provided along the whole route from the (un)loading area to the resting area and vice-versa. Care should be paid in order to avoid any light contrast, light reflection on metal equipment, or high luminosity because this causes animals to stop, and sometimes to turn back.
197. Mobile barriers can be used to create subgroups of animals. The barriers must be constructed in such way that they cannot harm or injure animals, and all materials used should be non-toxic, cleanable and easy to disinfect.

6.3 Feeding and watering

During transport pigs have no access to food, so it is important that they can drink and feed when rested.

Good practices for feeding and watering

198. The minimum quantity of feed should be **the level required for body maintenance** as shown in Table 6.2. Feed must be of homogeneous quality to avoid any competition for feeding.

Table 6.2 Minimum daily ration at control posts

Animal categories	Feed(kg/head/24h)
	Concentrate feed
Piglets < 15 kg	0,35
Weaners 16 to 50 kg	0,75
Growers 51 to 110 kg	1,00
Fatteners 111 to 160 kg	1,25
Sows, boars	1,50

199. The feeding equipment shall be constructed and installed so that **food contamination and competition among animals are minimised.**

200. If animals are fed ad libitum, at least 1 feeding place per 10 animals in group must be available. **If they are fed restricted, all animals in the pen must be able to eat at the same time.** The minimal feeder space per animal is described in Table 6.3.

Table 6.3 Suggested feeder space per animal to minimize the competition between animals

Animal categories	Feeder/trough space (m/head)	
	Linear	Circular
Piglets < 15 kg	0,15	0,12
Weaners 16 to 50 kg	0,25	0,20
Growers 51 to 110 kg	0,33	0,25
Fatteners 111 to 160 kg	0,40	0,33
Sows, boars	0,50	0,40

201. Feeding installations must be cleaned regularly and if necessary disinfected.

202. **Animals should have free access to fresh potable water,** delivered ad libitum. Drinking devices must be designed and positioned in a way that is appropriate for the species, the age and the size of animals (see Table 6.4). The minimum number of drinkers should 1 per 10 pigs. To avoid freezing, water pipes should be buried between 0,5 to 1 m deep and well insulated when in the building.

Table 6.4 Suggested height of installation above the floor of nipples and water bowls

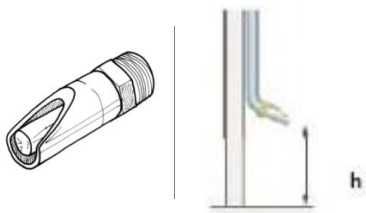
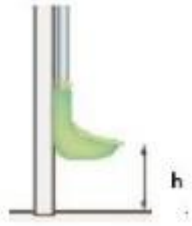
Animal categories	Height (h) of installation (m)	
	Nipples	Water bowls
		
Piglets < 15 kg	0,30	0,12

Weaners 16 to 50 kg	0,40	0,15
Growers 51 to 130 kg	0,50	0,20
Sows, boars	0,70	0,30

203. The **drinkers should not create obstacles** for animals, workers, machines and mechanical systems. They should not be placed next to feeding and resting areas, to avoid the risk of making the food or resting area wet.

Better Practices for watering

204. Water should be stored in a clean tank and the transporter must fill the tank with potable water during the journey.

6.4 Biosecurity, cleaning and disinfection

Transport conditions impose a close contact between animals and can increase the risk of pathogens spreading. Biosecurity is based on good hygiene practices aimed to limit pathogen development and spread, logistic management to prevent contacts between different consignments, and global management of the location to minimise sanitary risks and hazards. The owner of the location (but also the transporter) has to ensure the **bio-security criteria are followed in order to protect the animals** that are hosted. [Regulation \(EC\) 1255/97](#) sets down the requirements regarding the location, construction and operation of control posts that aim to achieve an appropriate level of biosecurity. Local competent authorities check that these requirements are fulfilled before approving control posts.

Good practices regarding biosecurity at control posts

205. Hygienic routing of transport is organised to prevent external transport (feed deliveries, removal transport of waste) to cross internal transport (animals). Different routes are clearly indicated to **separate 'clean' and 'dirty' routes** to: animal buildings, lorry wash station, feed and bedding storage, and manure storage. If physical separation is not possible, transports are separated in time. A plan to show the movement of all such vehicles or time separation to prevent cross overs should be made available.

206. The control post is **divided into zones** to allow the control post owner to plan for traffic patterns, work organization and biosecurity measures. Zones are large enough to permit later expansion without encroaching on other areas. Control posts can be divided into three concentric rings or activity zones: Zone 1 office and main entrance; Zone 2 accommodation for drivers, store house and truck wash; Zone 3 animal houses, truck parking and waste storages (See Figures 6.1 and 6.2).

207. Traffic areas and truck paths between entrance, (un)loading areas, truck wash and parking are planned according to the maximum size for trucks, trailer and semitrailers and to their radius of curvature.

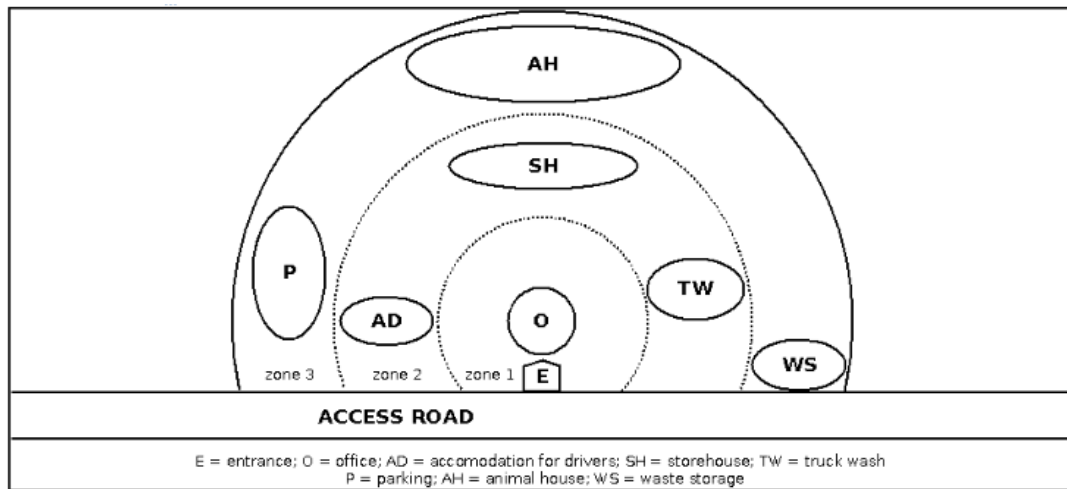

Figure 6.1 Example of the organization of a control post to optimize biosecurity

208. **Dead animals are stored in a separate building or sealed container (chilled)** and these facilities must be paved or floored with appropriate material. They should be cleaned and disinfected after every use. Carcasses are transferred to vehicles for transportation to the site of disposal or incineration in a manner that ensures these vehicles do not have to enter the premises of the control post (Regulation (EC) N. 1774/2002). Bedding and waste from these buildings should be removed and disposed of in an appropriate manner.
209. Animal buildings are **clearly marked**. Control post staff should be the only persons allowed to enter into these buildings of the control post. All people entering the building have to wear clean and control post-use clothes and shoes (or one-use disposable clothing) or walk through footbath facilities to disinfect the shoes before entering into the control post. The driver has to fulfil this procedure to handle animals into the control post. Bathroom should be available to visitors and drivers to wash their hands and themselves.

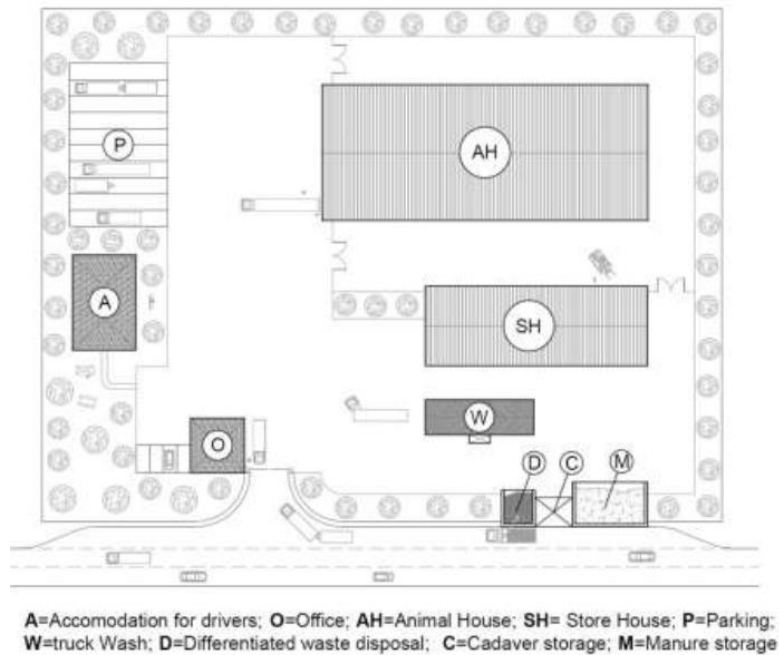

Figure 6.2 Possible organizational layout of a control post.

210. The cleaning, **removal of solid waste, washing and the disinfection of the building and equipment must be completed within 24h** from the time of removal of the animals from the pens. Buildings and equipment should be dry before a new batch of animals can be housed again. Cleaning of barriers and flooring (pens and ways) should be done using high pressure water (40-200 bars, 25 to 70 l/min).
211. **Warm water with detergent is specially recommended for metallic barriers.** Cleaning of drinkers and feeders can be done as partitions, floors and walls by using warm high pressure water, or if possible by soaking equipment 20 to 30 minutes in warm water and detergent before pressure cleaning. Foaming can improve the washing. When pens wall and barriers are clean and still humid, disinfection should be done.
212. **Authorized disinfectant products** should be sprayed according to manufacturers' recommendations. Only authorised products (under national agreements) can be used: for national lists of products, refer to official veterinarian and check for AFNOR reference (NFT 72-150/151, 72-170/171, 72-200/201, 72-180/181).

Better practices regarding biosecurity at control posts

213. Changing rooms separated from building in which animals are kept should be available both for co-workers, drivers and visitors (veterinarians, inspectors, etc.).
214. A basin with running hot and cold water, soap, disinfectants, clean towels are available in the changing rooms. **The control post shall have showers, toilets and leisure room for drivers and a well-kept first aid kit.**
215. **The control post should have communication facilities** available for drivers (telephone, fax, internet) and a website including: the name of the contact person of the control post, phone number, e-mail address, address, route planner, opening

- times, availability of facilities, language spoken, service available for driver (sanitation, leisure facilities, etc.) and health service. A phone list of local medical practitioners, hospitals, police, fire department, veterinarians must be available.
216. Water supply to animals should be potable and not become contaminated. Any water storage tanks must be covered and capable of being disinfected if necessary. **Water supply systems should be capable of being flushed with a sanitizer if required.**
217. Storage of feed and bedding must be kept secure and not capable of becoming contaminated. **Tractors and other mechanical equipment used for feeding and bedding should be cleansed and disinfected after each use.**

6.5 Emergency

In case of emergencies occurring while animals are at the control post, the contingency plan of the control post and that of the transporter are activated.

Good practices during emergencies at control posts

218. If there are not enough pens according to the number of pens in the truck, **no more than two pens of the truck are mixed**. Behaviour is observed and injured or stressed animals are isolated.
219. If an animal shows **signs of colic** (e.g. profuse sweating, continuous rolling, turning head towards the belly, persistent movement and getting up and down violently, lying down frequently), which is one of the most common problems, **veterinary assistance** is sought immediately. It is avoided as much as possible to stress the animal.
220. If **several trucks arrive together** at a control post with animals of different sanitary status:
- The **competent authorities** are contacted for official recommendations, also when one or more trucks create a biosecurity hazard.
 - Animals of **different sanitary status are isolated** in different areas of the site.
221. If a local **sanitary crisis** occurs when animals are expected at the control post:
- The **competent authorities** are contacted for official recommendations, also when one or more trucks create a biosecurity hazard.
 - The **driver and the owner** of the transported animals are informed before the arrival. Mobile disinfection systems (wheel splash-boards) are used when the truck enters the control post.

Better practices during emergencies at control posts

222. **If animals need to remain** in the control post after the truck has departed, for instance because they are injured or otherwise unfit to be transported, they are kept in a **separate area**. The local competent authorities are informed of these animals. No pens are disinfected whilst animals are still inside them. Care is taken not to cause avoidable stress.

References

For further reading, the following documents can be recommended:

- ABM/ABP, 2010. Livestock Transport Standards Version 2.3. 2010. www.lmcni.com/site/wp-content/uploads/2015/05/ABMABPTransport_Standards_v2.3_Dec_20101.pdf
- Amo Del León F.J., S. González González, G. Merchán Manzanares. Bienestar animal en el transporte de cerdos. Escuela de Ingenieros Agrónomos de Ciudad Real. <http://www.uclm.es/profesorado/produccionanimal/padr/trabajos/g3tbatc.pdf>
- Animal Health Australia (AHA), 2012. Australian Animal Welfare Standards and guidelines - Land transport of livestock, Canberra. <http://www.animalwelfarestandards.net.au/files/2011/02/Land-transport-of-livestock-Standards-and-Guidelines-Version-1.-1-21-September-2012.pdf>
- Anonymous, 2013. Quality Control Posts project website. <http://www.controlpost.eu/joomla/>
- Anonymous, Voorschriften QLL Diertransport [Standards of the QLL Quality Assurance Scheme].
- Averos, X., T. Knowles, S. Brown, P. Warris and L. Gosálvez, 2008. Factors affecting the mortality of pigs being transported to slaughter. *The Veterinary Record*, September 27 (2008), 386-390
- Canadian Agri-Food Research Council (CAFRC), 2001. Recommended code of practice for the care and handling of farm animals. Transportation.
- Defra, 2007. Welfare of Animals during Transport - Advice for transporters of pigs. Defra. https://www.gov.uk/government/uploads/system/uploads/attachment_data/file/69377/pb12544d-pigs-080711.pdf
- FAO, 2012. Buenas Prácticas Pecuarias (BPP) para la producción y comercialización porcina familiar. ISBN 978-92-5-306794-7. <http://www.fao.org/3/a-i2094s.pdf>
- Farm Animal Welfare Advisory Council (FAWC), 2007. Best Practice for the Welfare of Animals during transport. https://www.agriculture.gov.ie/media/migration/animalhealthwelfare/transportofliveanimals/BestPractice_WelfareAnimalsduringTransport.pdf
- Fédération des producteurs de porcs du Québec (FPPQ), 2010. Programme des bonnes pratiques de transport des porcs. Volet biosécurité et salubrité. Manuel du transporteur. http://leseleveursdeporcsduquebec.com/upa_porcs_files/producteurs/pdf/l720_s18_20101021_manuel_transporteur_bptp.pdf
- EFSA, 2011. Scientific Opinion Concerning the Welfare of Animals during Transport, EFSA Panel on Animal Health and Welfare (AHAW), European Food Safety Authority (EFSA), Parma, Italy. *EFSA Journal*, 2011, 9(1):1966. <https://www.efsa.europa.eu/en/efsajournal/pub/1966>
- ITG Formación Agraria, 2007. Guía de Buenas Prácticas para el Transporte de Ganado Porcino. <http://www.transportesdoctor.com/guia-de-buenas-practicas-de-transporte-de-ganado.pdf>
- Instituto Nacional de Investigaciones Forestales, Agrícolas y Pecuarias (INIFAP), 2011. Manual de responsabilidades para el transporte de cerdos.

- <http://www.sagarpa.gob.mx/ganaderia/Documents/MANUALES%20INIFAP/Manual%20de%20responsabilidades%20en%20el%20transporte%20de%20cerdos.pdf>
- National Animal Welfare Advisory Committee (NAWAC), 2011. Transport within New Zealand, Code of Welfare. <https://www.mpi.govt.nz/document-vault/1407>
- National Farm Animal Care Council / Canadian Pork Council (NFACC/CPC), 2014. Canadian Code of Practice for the care and handling of pigs. ISBN 978-0-9936189-3-2. <https://www.nfacc.ca/codes-of-practice/transport>
- National Pork Board, 2014. Transport Quality Assurance® Handbook, Version 5. <http://old.pork.org/filelibrary/tqa/2014-version5/tqahandbookv5.pdf>
- Nienhoff, H.J., 2015. Leitfaden Tiertransport Version 01.01.2015, QS Qualität und Sicherheit GmbH, Geschäftsführer. www.q-s.de
- North's Department of Agriculture DARD, 2015. 11 tips on transporting livestock in warm weather. <http://www.agriland.ie/farming-news/11-tips-on-transporting-livestock-in-warm-weather/>
- NVWA, 2012. Certificering van exporten vanuit en naar gebieden met extreme weersomstandigheden. https://www.google.it/?gfe_rd=cr&ei=9TguVqeCEMSg-gbvnZWYAg&gws_rd=ssl#q=https:%2F%2Fwww.nvwa.nl%2Fonderwerpen%2Fregel-s-voor-ondernemers-dier%2Fdossier%2Fdierwelzijn%2Fvoorschriften-dierenwelzijn-preventie-en-export
- OIE, 2015. World Organisation For Animal Health, Terrestrial Animal Health Code. Twenty-fourth edition, 2015. http://www.rr-africa.oie.int/docspdf/en/Codes/en_csat-vol1.pdf
- Pedernera C., Velarde A., Dalmau A., Ouweltj W., Messori S., Marahrens M., Steinkamp K., Chevillon P., 2014. Welfare assessment protocol for pigs during transport. Quality Transport and Control Post. Deliverable 2.2.b.
- Protection mondiale des animaux de ferme (PMAF) and Animals' Angels, 2009. Transport d'animaux vivants. Mémento de la réglementation. Un guide pour le contrôle sur route. http://www.civ-viande.org/wp-content/uploads/2015/07/brochure_transport_PMAF-1.pdf
- Quality Meat Scotland (QMS), 2014. Haulage Standards, Quality Meat Scotland Assurance Scheme <http://www.qmscotland.co.uk/sites/default/files/2014%20Haulage%20Standards.pdf>
- Qualität und Sicherheit GmbH (QS), 2015. Guideline Livestock Transport. Version: 01.01.2015. www.q-s.de/services/files/downloadcenter/4_leitfaeden/tiertransport/lf_trans_frei_01012015_en.pdf
- Pledl, M., Rabitsch, A., 2010. Handbuch Tiertransporte incl. Erleichterungen für landwirtschaftliche Transporte Stand 16.3.2010 https://www.verbrauchergesundheit.gv.at/handel_transport/tierschutz/tt_handbuch_kurzstrecke.pdf?4vgule
- Rossi P, A. Gastaldo, F. Guizzardi, 2010. Linee guida. Benessere dei suini durante il trasporto, l'attesa pre-macellazione e la macellazione. Provincia di Mantova. https://www.provincia.mantova.it/UploadDocs/4070_LineeGuida.pdf
- Royal Society for the Prevention of Cruelty to Animals (RSPCA), 2014. Welfare standards for pigs. <http://science.rspca.org.uk/sciencegroup/farmanimals/standards/pigs>
- SCAHAW, 2002. Report of the Scientific Committee on Animal Health and Welfare - The welfare of animals during transport (details for horses, pigs, sheep and cattle). European Commission – Health and Consumer Protection Directorate-General. Directorate C–Scientific Opinions.

UECBV EUROGROUP FOR ANIMALS, FVE, INAPORC, COPA COGECA, COOPERL ELT, ANIMALS ANGELS, IRU, 2016. Practical GUIDELINES to assess fitness for Transport of pigs. <https://agriculture.gov.ie/media/migration/animalhealthwelfare/transportofliveanimals/GuidelinesAssessFitnessTranpsortPigs050716.pdf>

VION, 2015. SOP of VION group for transporters.

Von Holleben, K., 2015. Personal communication. <http://www.bsi-schwarzenbek.de>

Welfare Quality® (2009). Welfare Quality® assessment protocol for pigs (sows and piglets, growing and finishing pigs). Welfare Quality® Consortium, Lelystad, Netherlands.



This Guide was produced by the Animal
Transport Guides consortium,
led by Wageningen Livestock Research